

**PERFORMANCE AND SIMULATIONS OF SMALL-SCALE SOLID WASTE
INCINERATORS AT NJOKERIO, NG'ONDU AND GREEN VALLEY AREAS IN
NJORO, KENYA**

Stephen G. Mugo Nyoti

**A Thesis Submitted to the Graduate School in Partial Fulfillment of the Requirements
for the Masters of Science Degree in Engineering Systems and Management of
Egerton University**

EGERTON UNIVERSITY

MAY, 2021

DECLARATION AND RECOMMEDATION

Declaration

I hereby declare that this thesis is my original work and that it has not been submitted for any award of a degree in this or any other university.

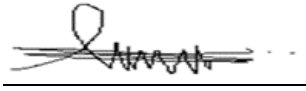
Signature:  Date: *03rd May, 2021.*

Stephen G. Mugo Nyoti

BM12/1795/06

Recommendation

This thesis has been submitted for examination with our approval as University Supervisors.

Signature:  Date: *04th May, 2021.*

Prof. Nyaanga, D.M.

Department of Agricultural Engineering, Egerton University,

Signature:  Date: *05th May, 2021.*

Prof. Owido, S. F. O.

Department of Soil Science, Egerton University,

Signature:  Date: *04th May, 2021.*

Dr. Owino G.O.

Department of Industrial and Energy Engineering, Egerton University,

COPY RIGHT

© 2021, Stephen G. Mugo Nyoti

All rights are reserved. No part of this publication may be reproduced, stored in a retrieval system or transmitted in any form or by any means: electrostatic, magnetic, mechanical, photocopying, recording or otherwise, without prior permission of the author or Egerton University.

DEDICATION

With love and sincere appreciation I dedicate this thesis to my dear wife Esther L. Mugo, children: Jabez Muriithi; Joab Asera; Job Munene and mum Mary Wanduma for the encouragement and unwavering support throughout the entire period of the study. May God Almighty bless them.

ACKNOWLEDGEMENTS

I give thanks to the Almighty God for His love, wisdom and knowledge that has bountifully enabled me to successfully complete this work. My heartfelt appreciation goes to my supervisors Prof. Nyaanga D.M., Prof. Owido S.F.O and Dr. Owino G.O. for their professional guidance, timely response, constant constructive comments and their tireless motivation and moral support. Special thanks to my employer, the Teachers Service Commission for granting me study leave. Special thanks and sincere gratitude to Mr. Muniu J.M. for his suggestions, support, positive criticism, encouragement, timely guidance and words of wisdom. I also acknowledge Mr. Mutumba M.K. of Animal Science Department for assisting me with muffle furnace equipment for the entire period of data collection. Thanks to Dr. Osodo B. for giving me the air flow meter and offering technical knowledge. This thesis could not have been completed without the support of staff and students of the Faculty of Engineering and Technology- Egerton University, who shared their knowledge and comments with me during my study. Last but not least my gratitude to colleagues and friends for giving me technical assistance, encouragement, moral and material support.

ABSTRACT

Solid waste management is challenging and incineration technique is more preferred to other methods in reduction of mass and volume, removal of odour and energy recovery in both industrial and residential environments. The challenges facing residents at Njokerio, Ng'ondeu and Green Valley areas included poorly designed open-wastes collection systems, exceeding incinerator loading rates, inappropriate operating temperature levels and inadequate design specifications. Objectives of this study were to characterize solid wastes, determine and assess factors influencing incineration performance and to simulate air flow patterns and velocity profiles for small-scale incinerators. Solid wastes collected from study areas were sun dried for three days, chopped into small pieces then separately packed into containers. Equipment used were eight small-scale incinerators, two muffle furnaces, flue gas analyser, electronic weighing balance, dryer, vibrator and chopping machines and air flow metre. Data collected was statistically analysed to determine trends, means, *F-values* and Least Significant Different at 5% confidence level. Characterized mean values for moisture content, volatile matter, ash content, fixed carbon were 41, 33, 15 and 11%, respectively while density had 257 kg/m³ and calorific values had 10 MJ/kg. Incinerating wastes at varying moisture contents (*MC*) from 15 to 75% produced mean emission values for carbon monoxide (*CO*), carbon dioxide (*CO*₂), and hydrocarbon (*HC*) ranging between 5 and 11 ppm, 5 and 14%, and from 508 to 1168 ppm, respectively. Varying incinerator loading rates from 15 to 75 kg/h yielded means *CO* ranging between 5 and 12 ppm, *CO*₂ from 5 to 14%, and *HC* between 252 and 1096 ppm. Moreover, increasing operating temperatures from 180 to 900°C contributed to mean values for *CO*, *CO*₂ and *HC* emissions ranging from 14 to 5 ppm, 15 to 6% and 1253 to 316 ppm, respectively. Simulation of Egerton University dispensary incinerator had a maximum air flow velocity of 5.2 m/s resulting into the best incineration performance while Community Resource Centre had the lowest of 1.9 m/s. Air flow and velocity profiles simulations of circular base-shaped incinerator model, projected best performance yielding maximum velocity of 6.4 m/s, whereas triangular base-shaped had the lowest of 4.3 m/s. High moisture contents, overloaded incinerators and low operating temperatures contributed to high gases emissions, leading to dark and dense smoke which resulted into incomplete combustion implying poor incineration performance. Wastes incineration at low loading rates, low moisture content and high operating temperatures produced finest and grayish white bottom ash, low levels of carbon and complete combustion. The small-scale incinerators are not incorporate with air pollution control devices hence cannot fully meet the emissions standards, although can lower if operated effectively.

TABLE OF CONTENTS

DECLARATION AND RECOMMENDATION	ii
COPY RIGHT	iii
DEDICATION	iv
ACKNOWLEDGEMENTS	v
ABSTRACT	vi
LIST OF FIGURES	xi
LIST OF PLATES	xii
LIST OF TABLES	xiii
LIST OF ABBREVIATIONS	xiv
LIST OF SYMBOLS	xvi
CHAPTER ONE	1
INTRODUCTION	1
1.1 Background.....	1
1.2 Statement of the Problem.....	3
1.3 Objectives	4
1.3.1 Broad objective.....	4
1.3.2 Specific objectives	4
1.4 Research Questions	4
1.5 Justification of the Study	4
1.7 Definition of Terms.....	5
CHAPTER TWO	8
LITERATURE REVIEW	8
2.1 Solid Waste Incineration.....	8
2.1.1 Incinerator types	9
2.1.2 Combustion processes	12
2.2 Characterization of Solid Waste	13
2.3 Factors Influencing Performance and Emission Levels from Waste Incineration	16
2.3.1 Effects of moisture content on flue gas emissions	16
2.3.2 Influence of incinerator loading rate on flue gas emissions	17
2.3.3 Effects of incinerator operating temperature on emissions	17
2.3.4 Assessment of smoke opacity at the chimney	17
2.3.5 Assessment of bottom ash residues	19

2.4 Air Flow Patterns and Velocity Simulations	19
2.4.1 Solid waste mass balance transport phenomena.....	21
2.4.2 Gas-phase balances transport phenomena	22
2.5 Statistical Design and Experimental Analysis	22
2.6 Compliance, Enforcement and Performance	23
2.6.1 Incineration compliance	23
2.6.2 Incineration enforcement.....	25
2.6.3 Incineration performance.....	25
2.6.4 Kyoto Protocol commitments and Stockholm Convention	25
2.6.5 The Environmental Management and Coordination Act.....	26
2.6.6 The National Environment Management Authority (<i>NEMA</i>)	27
CHAPTER THREE	28
MATERIALS AND METHODS	28
3.1 The study Area and Materials Preparation.....	28
3.1.1 Experimental set-up for the flue gases analyser	29
3.1.2 Muffle furnace incineration experimental set-up	30
3.2 Characterization of the Solid Wastes	31
3.2.1 Physical characterization of solid waste	32
3.2.2 Characterization of solid waste by combustion.....	33
3.3 Factors Influencing Solid Waste Incineration Performance on Gas Emissions	36
3.3.1 Effects of waste incineration at varying moisture contents.....	37
3.3.2 Influence of waste incineration at varying loading rates.....	38
3.3.3 Effects of waste incineration at varying operating temperatures.....	38
3.3.4 Assessment of smoke opacity at the chimney	38
3.3.5 Assessment of bottom ash residues	39
3.4 Simulation of Air Flow Patterns and Velocity Profiles for Small-Scale Incinerators	39
3.5 Analysis of Data.....	41
3.6 The Incineration Compliance, Enforcement and Performance	42
3.6.1 Incineration Compliance Assurance	42
3.6.2 Incineration enforcement.....	42
3.6.3 Incineration performance.....	43
CHAPTER FOUR	44
RESULTS AND DISCUSSION	44
4.1 Study Area Solid Waste Management and Incineration Facilities Design	44

4.1.1 Solid waste management	44
4.1.2 Incineration facilities design.....	45
4.2 Characterization of the Solid Waste	45
4.2.1 Moisture content	46
4.2.2 Volatile matters.....	47
4.2.3 Ash content	48
4.2.4 Fixed carbon	49
4.2.5 Calorific value	50
4.2.6 Density of solid wastes	51
4.3 Factors Influencing Performance of Solid Waste Incineration Processes	52
4.3.1 Effects of wastes incineration at varying moisture contents on emission levels.....	52
4.3.2 Influence of varying incinerator loading rates on flue gas emissions	55
4.3.3 Effects of incinerator operating temperature levels on flue gas emissions	59
4.3.4 Assessment of smoke opacity at the chimney	62
4.3.5 Assessment of bottom ash residues	63
4.4 Air Flow Patterns and Velocity Profiles Simulation for Small-Scale Incinerators	64
4.4.1 The Egerton University dispensary incinerator air-flow and velocity simulations .	65
4.4.2 The Green Valley residential incinerator airflows and velocities simulation	66
4.4.3 The Community Resource Centre incinerator airflows and velocities simulation ..	67
4.4.4 The Janda plaza incinerator airflows and velocities simulation	68
4.4.5 Incinerator design models and simulations	69
4.5 Compliance, Enforcement and Performance	71
4.5.1 Incineration compliance	71
4.5.2 Incineration enforcement.....	72
4.5.3 Incineration performance.....	72
CHAPTER FIVE	74
CONCLUSION AND RECOMMENDATIONS	74
5.1 Conclusion	74
5.2 Recommendations.....	76
REFERENCES.....	77
APPENDIX I	88
Dumpsite, Incinerators, Gas Analyzer and Model Simulations.....	88
APPENDIX II.....	93
Characterization and Incineration Processes Raw Data.....	93

APPENDIX III	103
ANOVA Results and Critical F-Values	103
The Research License	108
The Journal Publication Abstract.....	109

LIST OF FIGURES

Figure 2.1: Simplified schematic flow chart of an incinerator	8
Figure 2.2: De-Montfort small-scale bricks constructed incinerator type.	11
Figure 2.3: Relationship of temperature to excess air.....	12
Figure 2.4: Ringelmann cards with graduated black grids on white backgrounds.	19
Figure 2.5: Temperature and carbon monoxide concentration distribution.....	20
Figure 3.1: The study area.....	28
Figure 3.2: Diagram of a standard bomb calorimeter.	36
Figure 3.3: Small-scale residential solid waste incinerator at Janda Plaza.....	37
Figure 4.1: Moisture content mean wastes characterization from different areas	47
Figure 4.2: Volatile matter mean wastes characterization results from various areas.	48
Figure 4.3: Ash content mean wastes characterization results from different areas.....	49
Figure 4.4: Mean fixed carbon of wastes characterization from different areas.	49
Figure 4.5: Calorific value mean wastes characterization from various areas.	50
Figure 4.6: Density mean waste characterization from various areas.	51
Figure 4.7: Effects of moisture contents on emission levels.	53
Figure 4.8: Influence of incinerator loading rates on gas emissions.....	57
Figure 4.9: Effects of incinerator operating temperatures on flue gas emissions.....	60
Figure 4.10: Bottom ash residues from different experiments.	64
Figure 4.11: Airflow patterns and velocity profiles for dispensary incinerator.....	65
Figure 4.12: Incinerator airflow patterns and velocity profiles simulations.....	66
Figure 4.13: Air flow patterns and velocity profiles incinerator simulations.....	67
Figure 4.14: Air flow patterns and velocity profiles for the Janda Plaza incinerator.	68
Figure A1.1: Front view of the flue gas analyser.....	90
Figure A1.2: Rear view of the flue gas analyser.....	90
Figure A1.3: Square based incinerator model air flow patterns and velocity profiles.	91
Figure A1.4: Rectangular incinerator model air flow patterns and velocity profiles.	91
Figure A1.5: Circular based incinerator model Air flow patterns and velocity profiles.	92
Figure A1.6: Triangular based incinerator model air flow patterns and velocity profiles.....	92

LIST OF PLATES

Plate 2.1: Vulcan type small-scale incinerators.	10
Plate 2.2: Sicin type small-scale incinerator.	10
Plate 2.3: Dark and dense excessive particulate matter and low smoke opacity.	18
Plate 3.1: The experimental set-up for muffle furnace experiments.....	29
Plate 3.2: Muffle furnace incineration equipment.	30
Plate 3.3: Sorted residential solid waste awaiting disposal at Stalla residential.....	31
Plate 3.4: Mixed solid waste with high levels of polythene bags at Njokerio dump site.	32
Plate 4.1: The poorly designed incinerator resulting to open wastes burning	56
Plate 4.2: Non-performing incinerator at Sajendu Hostel due to poor design.	56
Plate 4.3: Dark and dense smoke at Community Resource Centre incinerator	62
Plate 4.4: Dark and dense smoke from overloaded incinerator at Green Valley.....	62
Plate A1.1: Stone built collection bin at Ng' Ondu areas damped with waste.....	88
Plate A1.2: Small-scale domestic incinerators at Green Valley areas.....	88
Plate A1.3: Good performance Small-scale incinerator at Egerton University dispensary.....	89
Plate A1.4: Air flow measurement into a small-scale incinerator at Stalla Hostel.....	89

LIST OF TABLES

Table 2.1: Classification and characterization of solid wastes.	13
Table 2.2: Solid waste proximate analysis from different authors.	14
Table 2.3: Ambient air quality and incinerator design allowable limits.....	24
Table 4.1: Mean solid wastes characterization results from different areas.....	46
Table 4.2: Effects of waste incineration at varying moisture contents on emissions.	52
Table 4.3: Influence of varying incinerator loading rates on flue gas emissions.	57
Table 4.4: Mean flue gas emissions at various incinerator operating temperatures.	59
Table A2.1: Solid waste characterization of moisture content, volatile matter, ash content, fixed carbon, density and caloric value raw data.....	93
Table A2.2: Waste incineration at varying moisture content of 15 and 30 % raw data.	94
Table A2.3: Waste incineration at varying moisture content of 45 and 60% raw data.	95
Table A2.4: Waste incineration at varying moisture content of 75% raw data.	96
Table A2. 5: Wastes incineration at varying loading rates of 15 and 30 kg/h raw data.	97
Table A2.6: Wastes incineration raw data at varying loading rates of 45 and 60 kg/h.	98
Table A2.7: Solid wastes incineration at varying loading rates of 75 kg/h raw data.	99
Table A2.8: Waste incineration at varying operating temperatures of 180 and 360°C.	100
Table A2.9: Waste incineration at varying operating temperatures of 540 and 720°C.	101
Table A2.10: Waste incineration at varying operating temperatures of 900°C.	102
Table A3.1: Mean and standard deviation results from solid waste incineration.....	103
Table A3.2: Critical Values of F-Distribution at 5 percent	104
Table A3.3: ANOVA results of solid waste characterization from different areas.....	105
Table A3.4: ANOVA results for solid waste incineration processes.....	106

LIST OF ABBREVIATIONS

<i>ac</i>	Alternating Current
ANOVA	Analysis of Variance
APCD	Air Pollution Control Devices
ASTM	American Society for Testing of Materials
BAT	Best Available Techniques
BEP	Best Environmental Practices
CFD	Computation Fluid Dynamics
CO	Carbon Monoxide
CO ₂	Carbon Dioxide
COHb	Carboxyhaemoglobin
CRC	The Community Resource Centre
CV	Calorific Value
EC	Environment of Canada
EIA	Environmental impact assessments
EMCA	Environmental Management and Coordination Act,
ENVILEAD	Environmental Liaison, Education and Action for Development
EPA	Environmental Protection Agency
EU	European Union
FC	Fixed Carbon
GHG	Greenhouse Gases
HC	Hydrocarbon
HCB	HexaChloroBenzene
HCWM	Health Care Waste Management
IPCC	Intergovernmental Panel on Climate Change
IPGCC	Integrated Plasma Gasification Combined Cycle
KAM	Kenya Association of Manufacturers
KeBS	Kenya Bureau of Standards
KNBS	Kenya National Bureau of Statistics
KNH	Kenyatta National Hospital
LSD	Least Significant Different

MC	Moisture Content
MSW	Municipal Solid Waste
μg	microgram (millionth of a gram)
μm	micrometre (millionth of a metre)
NEMA	National Environmental Management Authority
<i>ng</i>	nano-gramme (billionth of a gramme)
NGO	Non-Governmental Organization
PAH	Polycyclic aromatic hydrocarbon
PCBs	PolyChlorinated Biphenyls
PCDD	PolyChlorinatedDibenzo-p-Dioxins (dioxins)
PCDF	PolyChlorinatedDibenzoFurans (furans)
<i>pg</i>	picogram (10^{-12} of a gram)
PIC	Products of Incomplete Combustion
PM	Particulate Matter
$PM_{2.5}$	Particles Matter with an equivalent aerodynamic diameter of up to $2.5 \mu m$.
ppm	Parts Per Million
POPs	Persistent Organic Pollutants
PVC	PolyVinyl Chloride
SAS	Statistical Analysis of Systems
TEQ	Toxic Equivalency Quotient
UNEP	United Nations Environmental Program
U-POPs	Unintentional Persistent Organic Pollutants
USACE	United States Army Corps of Engineers
USBLM	United State Bureau of Land Management
USCAR	United State Climate Action Report
USEIA	United States Energy Information Administration
USEPA	United States Environmental Protection Agency
VM	Volatile Matter
VOC	Volatile Organic Compound
WHO	World Health Organization
<i>wt</i>	weight

LIST OF SYMBOLS

Symbol	Description	Units
ρ	Density of the fluid	kg/m^3
v	Velocity vector of the fluid	m/s
p	Pressure of the fluid	N/m^2
μ	Dynamic viscosity	$N/m^2 \cdot s$
F	Body force vector	N/m^3
I	Unit tensor	-
T	Absolute temperature	K
t	Time	sec
τ	Viscous stress tensor	$kg/m \cdot s^2$
μ_T	Turbulent eddy viscosity	$kg/m \cdot s$
∇	del operator for outer product tensor of the vector field	-
C_p	Specific heat capacity at constant pressure	$J/kg \cdot K$
C_μ and C_ε	Turbulence model parameter constant	-
σ_k and σ_ε	Turbulence model parameter constant	-
P_k	Production rate of turbulence kinetic energy	$J/m^3 \cdot s$
Q_c	Flue gas volume flow rate	m^3/s
ε	Dissipation rate of turbulence energy	J/kg
k	Thermal conductivity	$W/m \cdot K$
K	Turbulent kinetic energy	J/kg
V_{tot}	Combustion chamber volume	m^3
\vec{f}	Shear force (shear tensor)	N
g	gravity force	m/s^2
ζ_i	Bulk viscosity of phase	$kg/m \cdot s$
P_k	Production term	-
β_v	Surface tension force	N
\bar{X}	Mean of each sample	-
$\bar{\bar{X}}$	Mean of sample means	-

CHAPTER ONE

INTRODUCTION

1.1 Background

Solid waste management remains a big challenge in many parts of the world today. However, there are various waste disposal methods used to minimize solid waste such as recycling, open dumping, composting, landfilling, and incineration. Among these methods, incineration has become more popular in both industrial and residential environments. The solid waste characterization is a major factor, considered as a basis for the design of efficient, cost effective and environmentally compatible waste management system. The characterization of waste includes moisture content, fixed carbon, density, volatile matter, ash content and calorific value as emphasized by De Medina *et al.* (2013), Katiyar *et al.* (2013) and Ogwueleka (2009). The information on both waste quantities and composition is vital for monitoring progress towards best waste management option which includes garbage reduction and reuse for diverting materials from disposal facilities as Osei-Mensah *et al.* (2014) explicitized.

The incineration processes results in very significant waste energy recovery, odour removal and reduction of mass from 80 to 85% and volume between 95 and 96% for safe disposal on land, or in underground pits as reported by Astrup *et al.* (2011) and Manyele *et al.* (2011). This process involves waste drying, volatilization, combustion of fixed carbon and char burnout followed by combustion of vapours, gases and driven-off particulate residues as specified by Van Caneghem *et al.* (2012) and Chang *et al.* (2009). The combustion process depends upon the design, air mixture held at high temperatures, long resident time to allow complete oxidation and enough turbulences of gases as Omari (2013) and Lombardi *et al.* (2013) expressed. These furnace conditions assures complete destruction of even the most stable organic compounds. In their study Petridis and Dey (2018) and Chen *et al.* (2010) established that plant incineration performance was subject to wastes quality and quantity and varies over time in certain locations due to variability in solid waste generation and seasonality.

High moisture content and poor turning of solid wastes will lead to incomplete combustion resulting into high energy consumption, high environmental pollution and high exposure risks as observed by Neuwahl *et al.* (2019) and Würdemann and Van-Veen (2002). According to Oumarou *et al.* (2012), high moisture content is responsible for the low calorific value, a longer residence time as well as combustion instability and low efficiency. The operating temperatures is a function of waste heating value, furnace design, air admission, combustion control of enclosure materials and bottom ash quality and quantity as described by Tchobanoglous and Kreith (2002). The incinerators overloading results into poor combustion burndown, causing

excessive emissions due to rapid generation of volatile matters leading to overflowing of secondary chambers. Under-loading on the other hand, results into inadequate thermal input and necessitate use of auxiliary fuel to maintain the desired set point temperature as recommended by Tao *et al.* (2017) and Moora *et al.* (2012). The operating temperatures of above 850°C and gas holding time of two seconds were needed for dioxins and furans and other persistent pollutants full destruction as Zhu *et al.* (2013) established.

The products of incomplete combustion range from low molecular weight hydrocarbon to high molecular weight compounds (including dioxins and furans) which cause serious health effects as emphasized by Zhang (2012), Park *et al.* (2013) and Wu *et al.* (2014). The carbon monoxide (*CO*) arises in furnaces where there is deficiency of oxygen for full oxidation and is a product of incomplete combustion. The *CO* is an important indicator of combustion processes and quality criterion for level of flue gases. According to Neuwahl *et al.* (2019) the facility *CO* is measured continuously and its daily average means should be below 50 ppm. The volatile organic compounds are products of incomplete combustion covering a wide range of compounds, as they include carbon chains having high vapour pressure as expressed by Quina *et al.* (2011) and Xie *et al.* (2010). The greenhouse gases (*GHG*) consisting of carbon dioxide, methane, nitrogen dioxide, chlorofluorocarbons and ozone. The *GHG* causes sporadic changes in weather patterns and could make parts of the planet uninhabitable as established by Ujam and Eboh (2012), Chen and Lin (2010) and Muriithi (2009). Other emissions from incinerators includes carbon monoxide, hydrocarbon, hydrogen chloride, sulphur oxides, dioxins and furans. The dioxins and furans are highly toxic pollutants that have been linked to types of cancers, liver problems, endocrine and reproductive systems. These pollutants persist in the environment for long periods, bioaccumulation in plants and animals and have been identified for elimination as Government of Nunavut (2012) recommended.

The main problems associated with incineration processes are large volume of gaseous emissions which may pose environmental health risks and hazardous solid residues that remain after as fly ash and bottom ash as established by Park *et al.* (2013) and Quina *et al.* (2011). The bottom ash is highly toxic and handling raises serious concerns to exposed workers, sometimes with little or no protective gear as expressed by Xie *et al.* (2010) and Rogers and Brent (2006). Moreover, lack of secure landfills for bottom ash may lead to it being dumped in unlined pits, where it runs the risk of contaminating groundwater. Sometimes the dioxin-rich ash residues find its way into the towns dumpsites (Earle, 2003; Guendehou *et al.*, 2006; Thompson & Anthony, 2005). The fly ashes collected in air pollution control equipment consists of smaller and lighter particles residues in flue gases and is highly poisonous if allowed into the

environment as observed by Bernardo (2011). These problems occur due to non-performance of incineration facilities.

The simulations shows detailed flow combined with mass and heat transfer, effects on air velocity and temperature distribution in combustion zone. It also exhibits concentration of evaporated solvent in thermal drying oven and provides flexibility to change design parameters as illustrated by Sachdev *et al.* (2012). The chimney emission parameters used in assessing the performance of air pollution control devices includes flue gases pressure, velocity, moisture content levels, smoke opacity and sizes of particulate matter. Health and safety is a conscious priority and should be integrated into all aspects of incineration operation facilities. Incinerators should be designed to identify, evaluate and control safety and hazards as UNEP (2019) and Castellani *et al.* (2014) established.

The Environmental Management and Co-Ordination Act stipulates corresponding duties, mandatory policies and strategies of solid waste management under supervision of the National Environment Management Authority. The standards/limits regulations specify requirements for waste segregation into wet, dry or special and restriction on material disposal using incineration or landfill. It also include levy fees, provision of on-spot fine on littering, environmental clearances for disposal facilities, composting and mandatory annual reporting on operations as recommended by Kumar *et al.* (2017) and White and Heckenberg (2012).

1.2 Statement of the Problem

The urban development, population increase and changes in consumption pattern have directly resulted in the generation of enormous amount of waste, ranging from biodegradable to synthetic. The physical and chemical characteristics of solid waste from the study areas such as moisture contents, volatile matters, ash content, fixed carbon and calorific values and their effects on incineration performance remained unknown.

The practice of open burning outside incinerators and continuous emission of noxious heavy dense smoke that are carried to home causes distress to the residences. Besides, large quantities of unburned plastics, papers, woods, and gauze in the bottom ash exhibited incomplete wastes combustion and poor solid waste handling. Low operating temperatures and overloading of incinerators with high moisture content in solid wastes were found to be possible causes of incomplete combustion and emissions of dark and dense smoke opacity from chimneys. There were also notable deficiencies in air flow inlet designs and construction of the subjects investigated which contributed to poor performance, low incinerator operating temperatures, incomplete waste destruction and fugitive emissions. The effective solid waste

management is important for estimating material recovery potential, identifying sources of component generation, facilitate design of processing equipment, estimate physical, chemical, thermal properties and incineration of the waste and to maintain compliance with national law and directives. Among these methods, incineration has been preferred since it would highly reduce waste and tendency of open-burning.

1.3 Objectives

1.3.1 Broad objective

The broad objective of the study was to evaluate factors affecting the performance and simulations of small-scale solid waste incinerators at Njokerio, Ng'onde and Green Valley areas in Njoro, Kenya.

1.3.2 Specific objectives

The specific objectives were to:

- i. Determine the characteristics of solid wastes from Njokerio, Ng'onde and Green Valley areas.
- ii. Determine and assess the factors influencing the incineration performance and emissions of small-scale solid waste incinerators.
- iii. Simulate the air flow patterns and velocity profiles for the small-scale incinerators.

1.4 Research Questions

- i. How would the characteristics of solid waste from Njokerio, Ng'onde and Green Valley areas be determined?
- ii. How would factors influencing the incineration performance and emissions of small-scale solid waste incinerators be determined and assessed?
- iii. How would the air flow patterns and velocity profiles for the small-scale incinerators be simulated?

1.5 Justification of the Study

In this research, the effects of solid waste incineration at varying moisture contents, loading rates, operating temperature levels and small-scale incinerators simulations were determined; while smoke opacity and bottom ash residues were assessed. It was confirmed that the Egerton University dispensary small scale incinerator had the best incineration results hence was used as the standard for others. Simulation of air flow patterns and velocity profiles showed that circular-base shaped incinerator was more preferred to other design models since it had the best incineration performance. The increased solid waste dumping, handling and issues of open-

burning from the study areas has resulted into increased environmental degradation due to some components of hazardous waste including the heavy metals and organic pollutants. The degraded environment can be breeding grounds for other social ills such as impaired health or declined social cohesion. The research identified and quantified factors influencing the performance and emissions of small-scale solid waste incinerators and suggested feasible recommendations based on concrete findings of the study. These findings would also enable planners and policy makers to take appropriate actions that are helpful for improving efficiency in solid waste disposal. Maintaining the overall cleanliness of Egerton University and its environs would contribute significantly to the quality of life, health as well as sanitation.

1.6 Scope and Limitations

The study characterized solid wastes sampled from Njokerio, Ng'ondeu and Green Valley areas based on moisture content, volatile matter, and ash content, fixed carbon, density and Calorific Value. The incineration performance was evaluated in terms of carbon monoxide (CO), carbon dioxide (CO₂) and hydrocarbon (HC) emissions including the assessment of smoke opacity and bottom ash residues. The incinerator design models were simulated using square, rectangular, circular and triangular based shapes and the study involved eight (8) small-scale incinerators. This research was confined to solid wastes from residential environment, but did not analyze potentially infectious medical waste; hazardous waste; special waste which includes chemicals and x-rays waste; industrial process waste such as electronics, biomedical and chemical drugs, cells and batteries.

1.7 Definition of Terms

Agricultural wastes: Agricultural waste includes spoilt food remains, vegetable, grass and litters from farm yards, animal manures, plants and others vegetation.

Air Pollution: Air pollution is presences of harmful materials into environment which interfere significantly with comfort, health and welfare of persons, or use and enjoyment of properties.

Air Pollution Control Devices: Air pollution controls are the equipment/devices used to lower or eliminate pollutions to environment as part of engineering controls on emission sources.

Air Quality Standards: Air quality standards is the level of pollutants by law that cannot be exceeded during a specified time in a defined area.

Bottom Ash: Bottom ash are residues collected from incinerators after completion combustion process by municipal, industrial, hospitals and apartments.

Calorific value: Calorific value is the substance heating energy set at free incineration process for unit of mass (or volume) derived from coals, wastes, natural gases or petroleum products.

Categorization: Categorization is the process of sorting, arranging or organizing various things/elements into classes considering objects, events and people.

Waste Characterization: Waste characterization is the process by which composition of different garbage materials is analysed. Its helps in planning how to reduce waste, set up recycling programs, and conserve money and resources.

Commercial waste: Commercial waste includes groceries, leftovers food, broken bottles, plastics and ash from motels, supermarkets, cyber and barbecues.

Emission: Emission is the act of sending or throwing out specific pollutants through waste incineration at the chimneys.

Fly Ash: Fly ash comprises of small and light fine residues generated from combustion chambers entrained in flue gas and collected in air pollution control devices.

Hazardous Wastes: Hazardous wastes are those which are dangerous to living organisms in the atmosphere, immediately or after some time to due to its disposal and may be ignitable, corrosive, reactive and toxic.

Incineration: Incineration is a process of destroying wastes in a controlled burning at high temperature, oxidizing carbon and hydrogen, converting into inert, generates heat energy and reduces its mass and volume.

Incinerator: Incinerator is a device/structure intended primarily to incinerate waste for purpose of reducing its volume, destroying hazardous or infectious substance at a controlled burning and ventilation processes.

Industrial wastes: Industrial waste include chemicals, paint containers, explosives, furniture, refrigerators, home appliances, plastics and polythene papers.

Institutional waste: Institutional wastes are generated from schools, colleges and offices which includes papers, rubber, polythene papers, clothes, hand glasses.

Isothermal process: Isothermal processes takes place at a constant temperatures, where isothermal expansions adding of heat is continuous while in isothermal compressions there is continuous removal of heat.

Model: Model is a system of postulates, data, material, visual and inferences presented as mathematical or computational with description of entity or state of affairs and is used in construction of scientific theories.

Modelling: Modelling is the processes of model representations and allowing ideas to be investigated including constructions or creation of artefact forms.

Monitoring: Monitoring is periodic or continuous surveillance or testing to determine levels of compliance with statutory requirements and the pollutant levels in various media or in humans, animals, and other living things.

Municipal solid waste: Municipal solid waste includes thrown away materials like packages, clothes, plastics, polythene papers, photocopying papers, leathers, rubbers from residential, commercial, institutions and medical areas.

Non-combustibles: The Non-combustibles materials are not capable of burning or catching fire remaining after combustion processes and includes inert materials like glass, soil, sand, stones and metals.

Open Burning: Solid waste open burning is uncontrolled incineration of combustible materials resulting into incomplete combustion, directly releases harmful pollutants into environment.

Performance: Performance is the act of carrying an execution, achievement, accomplishment and representation by action.

Residential waste: Residential/Domestic refers to waste generation from dwellings, apartment and hostels includes leftovers, peelings, vegetable, clothing and ash residues from jikos.

Residence time: Residence time also called holding or retention time is duration available to ensure complete mixing of air and fuel, hence complete incineration of solid wastes.

Simulation: Simulation is to imitate a system operations in order to predict the actual behaviour and helps in optimization to pursue analysis, design, and control processes beyond reach of the decision makers.

Small-scale incinerator: Small-scale incinerator ranges from 12 to 100 kg/hr of solid waste which includes the Vulcan and Sicin metallic and De-Montford bricks constructions designs.

Smoke: Smoke is the flue gases, particulate matters and other incineration residues emitted into the environments through the chimneys.

Smoke opacity: Smoke opacity is the obscuring power of the flue gases emissions expressed as a percent when viewed through the Ringelmann chart.

Solid Waste: Solid waste is any garbage, refuse, sludge and other discarded material with low liquid content including the municipal, industrial, commercial, demolition, mining residues, agricultural and animal husbandry wastes.

Solid Waste Minimization: Solid waste minimization is application of activities such as waste avoidance, reduction, reuse and recycling to minimize amount of materials requiring disposal.

Solid Waste Management: Solid waste management is the process of handling, collecting, treating, and disposing discarded materials posing a wide variety of economic, administrative and social problems which must be managed and solved.

CHAPTER TWO

LITERATURE REVIEW

2.1 Solid Waste Incineration

The solid waste incineration produces high levels of hazardous by-products of which only a handful has been studied thoroughly as emphasized by Miezah *et al.* (2015) and Buekens and Cen (2011). Some toxic emissions from incineration includes carbon dioxide, carbon monoxide, hydrocarbon, hydrochloride, heavy metals, dioxins, furans, Unintentional Persistent Organic Pollutants (U-POPs), fly ash and bottom ash as established by ENVILEAD (2005). According to Guendehou *et al.* (2006) and Batterman (2004), municipal and medical solid waste incineration facilities are among the top sources of dioxins and furan released into environment making up to 1100 and 477 ngToxic Equivalent (TEQ) per year, respectively.

Incineration is a controlled combustion process for reducing solid, liquid, or gaseous combustible waste materials into carbon dioxide, water vapor, other gases and noncombustible residues. A simplified schematic flow chart of incineration plant is illustrated in Figure 2.1.

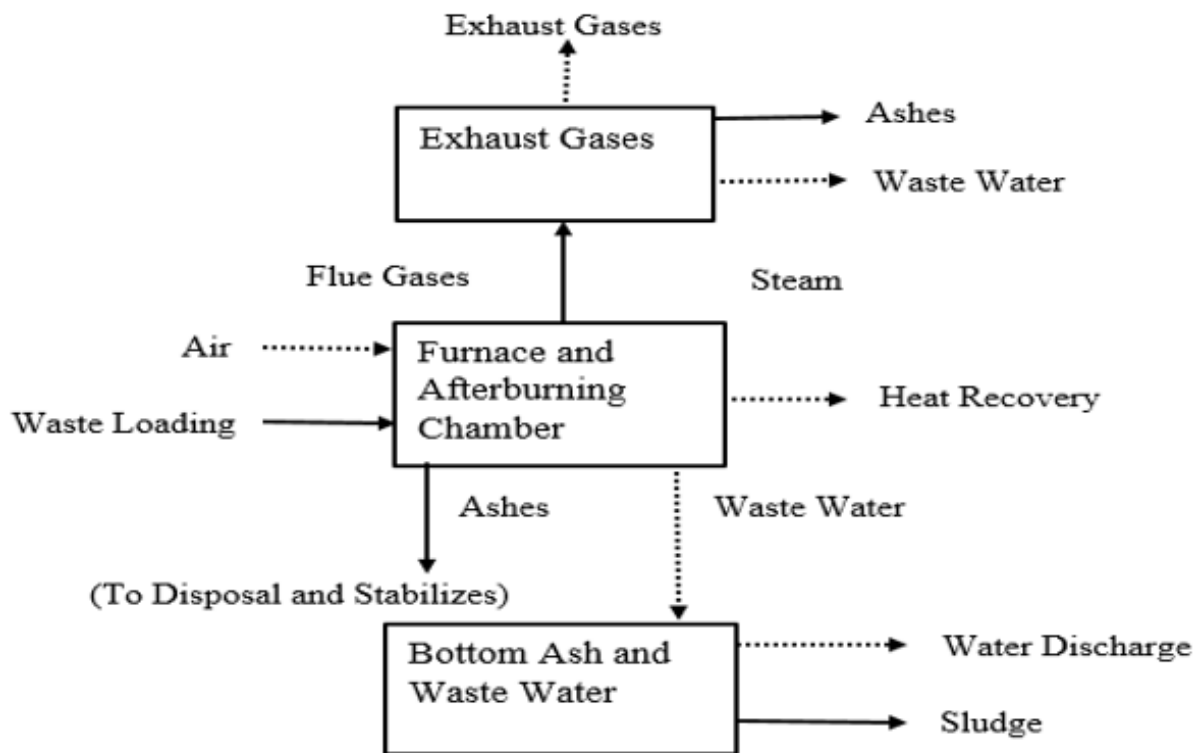

Figure 2.1: Simplified schematic flow chart of an incinerator

Source: Neuwahl *et al.* (2019) and UNEP (2008)

Incineration plant includes: waste reception and handling; combustion chambers; energy recovery; gaseous emissions clean-up facilities; on-site treatment of ash residues and waste water storage containers; chimney; controlling operations devices, recording and monitoring

conditions as explicitized by Quina *et al.* (2011) and Rimaitytè *et al.* (2010). The heat energy produced from incineration can be recovered either in form of electricity, heating hot water or steam in boilers. Exhaust gases leaving boilers carry noxious emissions which should be passed through flue gas cleaning system to remove pollutants, before being discharged to environment. Bottom ash from furnaces is disposed into underline pits, upgraded or used in road building construction. As observed by Tangri (2003), that despite intensive scrutiny over many years, much remains unknown about the releases of pollutants from waste open burning activities.

2.1.1 Incinerator types

The two main types of incineration facilities are the large scale and small-scale. Primary combustion chamber is constructed from high carbon steel lined with refractory bricks. Grates is made of treated high carbon steel to withstand high temperatures. Induced draft fan draws combustion gas from scrubber, maintaining flow to the chimney. Stack is constructed of steel and sometime lined with refractory bricks and must be above 3 m taller than the tallest building. The incineration plant includes the pollution mitigation equipment for flue gas cleaning.

a) Large scale incinerators

The large scale incinerators can handle solid wastes of up to 35 metric tonnes per hour operating for over 8,000 hours per year with one scheduled inspection and maintenance period of one month as emphasized by Matee and Manyele (2015). Some of large scale types include; typical hopper rams assembly, single batch controlled-air, step hearths with automatic ash removal, moving gate, fixed grate, rotary kiln, fluidized bed, sludge and excess air incinerators as established by Guendehou *et al.* (2006) and Würdemann and Van-Veen (2002). The moving grate incinerator enables wastes movement through combustion chamber for high efficiency and complete combustion optimization. It also incorporated with air pollution control devices (APCD) and temperature control as well as flame ignition burners. According to Van Caneghem *et al.* (2012), asserted that large scale incinerators yet pollutes environment due frequent malfunction including poor operations and designs which can be alarming.

b) Small-scale incinerators

The loading rates for small-scale incinerators ranges from 12 to 100 kg/h, requiring small-sized or shredded wastes and are built with locally available materials as clarified by Batterman (2004). A research done in Kenya by Taylor (2003) indicated inadequate quality control in incinerators' construction phase leading to high level of emissions. Nevertheless, with proper material lists selection, an adequate plan, dimensional drawings, construction phase, quality

control and tolerance are important. The Vulcan and Sicin incinerators shown in Plate 2.1 and 2.2 are some of the recommended small-scale types used for residential and medical facilities.

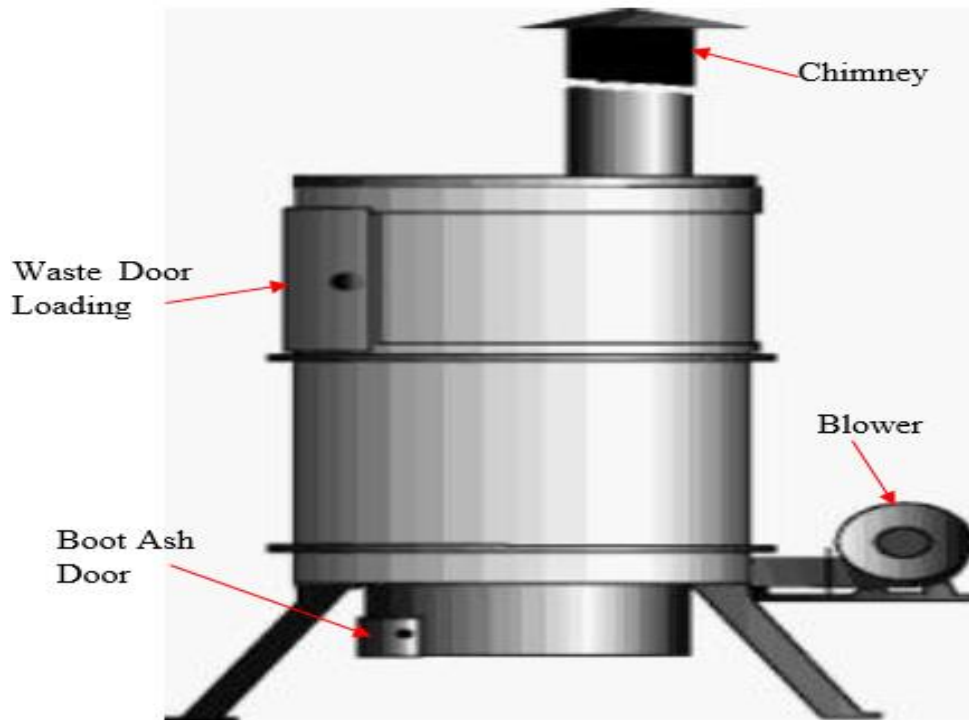

Plate 2.1: Vulcan type small-scale incinerators.
Source: Batterman (2004)



Plate 2.2: Sicin type small-scale incinerator.
Source: Batterman (2004)

The Vulcan and Sicin small scale incinerators can achieve up to 900°C, handling about 400 kg/day of solid wastes. The incinerators are either rectangular shaped having length, width and height of dimensions 1.1, 0.75 and 2.5 m respectively, or a cylindrical shaped with height of 2.5 m and diameter 1.2 m as established by Batterman (2004). The unburned bottom ash falls through grates during burning process making the removal easier once sufficient amount has accumulated. Combustion air enclosed in Vulcan and Sicin is typically provided by air blower at the bottom of incinerator allowing for better mixing with burning garbage. The combustion heat from primary chamber and radiant heat from furnace walls dries up solid wastes as burning continues. The vaporization of volatile components and moisture content in wastes passes along with flue gases to secondary chamber maintaining a temperature of 850°C for complete combustion. Flue gases exiting are directed to the chimney or through APCD. The De-Montfort small-scale bricks constructed incinerator type is illustrated in Figure 2.2.

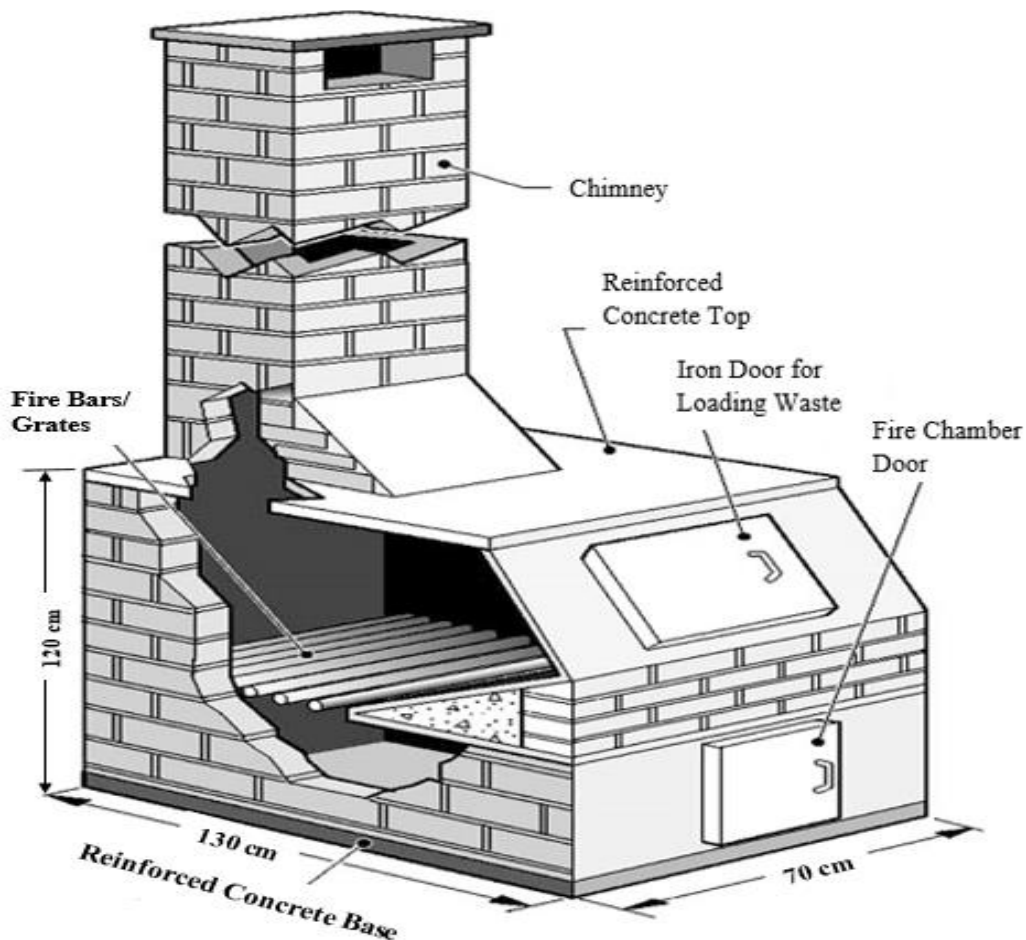

Figure 2.2: De-Montfort small-scale bricks constructed incinerator type.
Source: Ombacho (2009)

Moreover, Niessen (2010) established that De-Montfort constructed bricks incinerators had a capacity of destroying completely the combustible residential and medical solid wastes. The

De-Montfort-bricks is manufactured using locally available fabricated metal parts, firebricks and structure's assembly using Portland cement for walls constructions and refractory cement for firebricks bonding. The incinerators comprises of primary and secondary combustion chambers as expressed by Talsania and Modi (2019). The accessible primary combustion chamber has a front door for wastes loading, air-vent door that allows air in, fire lighting and bottom ash removal container. However, inaccessible secondary combustion zone, partitioned by a column of bricks from the primary, has a bottom opening for cross-draft induction and auxiliary burners necessary for operations as expressed by Ombacho (2009).

2.1.2 Combustion processes

The combustion process is a rapid chemical combination of combustible fuel elements with oxygen. According to El-Mahallawy and Habik (2002) when excess air exceeds stoichiometric point, temperature is lowered due to used up energy in heating air from ambient to combustion as presented by Figure 2.3. Moreover, Bradfield (2014) reported that European legislation imposed a minimum gas phase combustion temperature of 850°C and at least two seconds residence time. In a report published by Ayaa *et al.* (2014), the maximum temperature attainable in an ideal case is 1000°C, but due to heat losses incurred, assumption is made to reach 850°C in one hour. When operating incinerators under very low temperatures, fluorine and chlorine is converted into hydrocarbon (HC) and hydrogen halides which reacts forming metal chlorides. However, hydrocarbon emissions is considered health hazardous due to its toxic reproduction properties, genotoxicity, immunotoxicity and carcinogenic as expressed by Huang *et al.* (2016) and You (2008), hence it should be reduced.

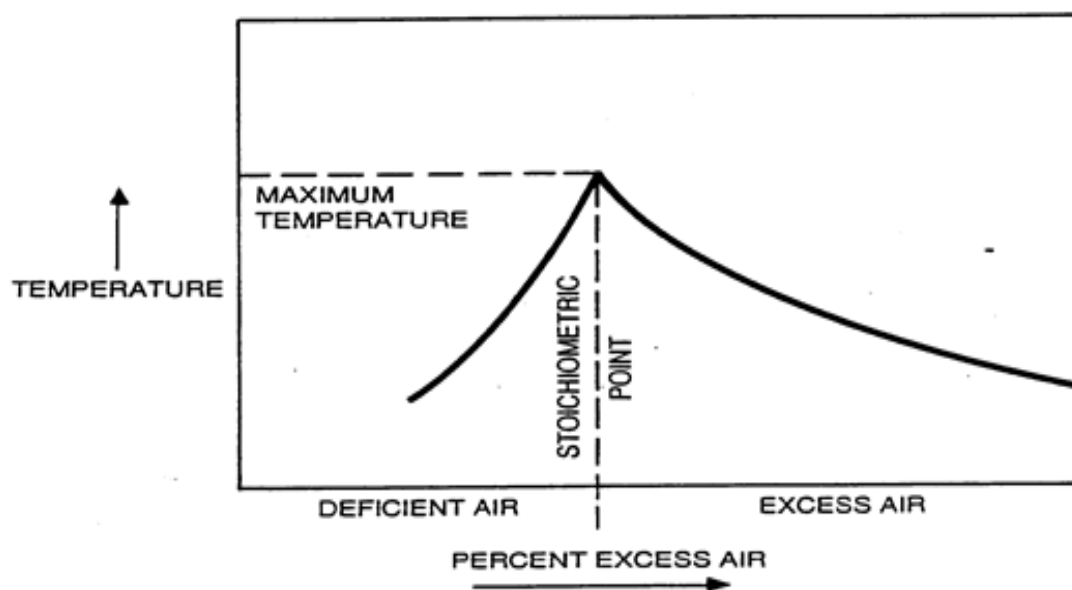
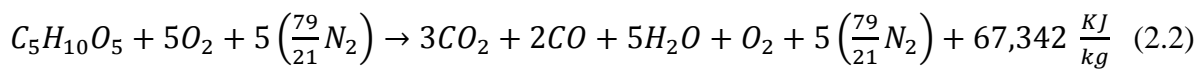

Figure 2.3: Relationship of temperature to excess air.
Source: El-Mahallawy and Habik (2002)

The incineration of solid wastes containing oxygen (O₂) compounds and being available in combustion process, less air is required as established by Basham *et al.* (2004). However, if incomplete combustion occurs, then carbon monoxide (CO) would be formed as illustrated by Rajput (2007) and El-Mahallawy and Habik (2002) in chemical Equation 2.1.



The concentrations of oxygen and carbon dioxide in flue gaseous streams are useful indicators of complete combustion and are used to monitor combustion processes as expressed by Eastop and Mc-Conkey (2002). According to Manahan (2017), the cellulose component constituting of photocopying paper, cartons, newspaper and books waste stream products combustion reaction is shown in Equation 2.2.



2.2 Characterization of Solid Waste

The characterization is necessary for different waste streams to ensure proper incinerator design and selection. The classification and characterization of different solid waste types is presented in Table 2.1.

Table 2.1: Classification and characterization of solid wastes.

Classification of Wastes	Principle Components	Moisture content (%)	Incombustible solids (%)	Heating Value (kJ/kg)	Aux. fuel L/ton of waste
Type 0 - trash	Highly combustible Paper, plastics	10	5	4,700	-
Type 1 - rubbish	Paper, wood, cartons cardboard, sweepings	25	10	3,600	-
Type 2 - refuse	Rubbish and garbage from Residential	50	7	2,400	-
Type 3 - garbage	Food wastes, grains vegetable agricultural	70	5	1,400	800
Type 4 - organic	Carcasses organics, organic wastes, animal	85	5	550	1,670

Sources: Basham *et al.* (2004)

The amount and characteristics of solid waste generated depend on factors, like population, standard of living, season, life style, topography and industrialization (Kumar *et al.*, 2017). The

proximate waste analysis is done to establish the composition and heating value in terms of components like fixed carbon, volatile matter, moisture content (MC) and ash content as noted by Talsania and Modi (2019), Salami *et al.* (2011) and Arsad *et al.* (2006). The type one (1) with trash or garbage wastes which emanates from residential apartments consisting of peeled material, vegetables, leftover scrapes food, wood pieces, plastics, ashes and clothes. The type three wastes had mean moisture content of 70% and calorific value (CV) of 1.4 MJ/kg while type two (2) had mean MC of 50% and CV of 2.4 MJ/kg. On the other hand, type zero (0) consist of papers, plastics, refuse which are highly combustible wastes having MC of 10 % and CV of 4.7 MJ/kg. As observed in Table 2.1, the first three types did not require auxiliary fuels when incinerating since their heating values were above 2.4 MJ/kg as recommended by Niessen (2010) and Moora *et al.* (2012). The proximate waste analysis which includes volatile matter, moisture content, ash content, fixed carbon, density and calorific values from various authors are shown in Table 2.2.

Table 2.2: Solid waste proximate analysis from different authors.

Authors	Moisture content (%)	Volatile matter (%)	Fixed carbon (%)	Ash content (%)	Density (kg/m³)	Calorific value MJ/kg
Arsad <i>et al.</i> (2006)	-	82.7	8.6	8.8	-	21.0
Ayeleru <i>et al.</i> (2016)	62.6-65.5	21.8-22.9	6.3-10.3	5.4-5.9	-	-
Kalanatarifard and Yang (2012)	54.0	16.0	16.0	14.1	-	-
Katiyar <i>et al.</i> (2013)	16.1-41.9	32.4-58.2	6.5-11.6	9.7-22.9	212-411	0.4-4.7
Miezah <i>et al.</i> (2015)	25.0-75.0	31.0-88.0	-	2.2-19.0	-	13.9-29.9
Omari (2013)	55.7-64.0	30.0-34.7	1.7-7.0	3.2-6.0	-	11.9-12.6
Oumarou <i>et al.</i> (2012)	26.7-32.6	20.5-25.3	10.0-16.6	32.2-34.8	-	5.4-5.7
Oumarou (2015)	17.4-23.3	19.3-34.5	11.1-26.9	31.6-37.4	-	5.0-5.9

Sources: Various authors as in the table.

In his study Omari (2013) noted that moisture content (MC) of solid wastes in Arusha, ranged from 56 and 64%. He also established that ash content (AC), volatile matter (VM) and fixed carbon (FC) ranged between 3 to 6%, 30 to 35% and 2 to 7% respectively. According to Oumarou *et al.* (2012) solid wastes proximate analysis in North-Central of Nigeria had MC of 27 to 33%, VM of 21 to 25%, AC of 32 to 35%, FC of 10 to 17% and calorific value of 5 to 6

MJ/kg. However, in line with Oumarou (2015) the mean values of wastes proximate analyses for AC , MC , FC and VM varied from 32 to 37%, 17 to 23%, 11 to 27% and 19 to 35%, respectively.

a) Moisture content

Moisture content (MC) of solid wastes is that which moistens, making damp or wet hence lowering fuel quality as expressed by Ayeleru *et al.* (2016), Dong *et al.* (2016) and Suthapanich (2014). High MC decreases wastes heating value thus reducing the performance and efficiency because large amount of energy is used for vapourization which discourages the combustion sustainability (Arsad *et al.*, 2006; Kuleape *et al.*, 2014; Omari, 2013; Saeed *et al.*, 2009).

b) Volatile matter

Volatile matter is the vapourizing or evaporating readily released under normal conditions by solid wastes during incineration. The volatile matter represents products that vapourize when drying/heating in a controlled condition of air flow, temperature and residence time as Pinasseau *et al.* (2018) expressed. During the devolatilization process, volatile matter is determined by heating in a covered crucible to avoid air contact, which is also used in determination of pyrolysis capability in wastes. High volatile matters indicates release of vapour combustion as free board of heating values as Astrup *et al.* (2011) and Chang *et al.* (2011) emphasized.

c) Ash content

Ash content is the residues (non-combustible matter) that remained after incineration of solid waste or substance at high temperature in a furnace. The fine particulate matters (PM) of fly ash in air would results into severe levels of environment pollution since it consists of elements like zinc, mercury, copper and lead (Bernardo, 2011; Chang *et al.*, 2009; Suthapanich, 2014). In their research Arsad *et al.* (2006) observed that solid wastes with high levels of plastic materials, its ash content reduced to 8.8% after incineration processes. On the other hand, Sørnum *et al.* (2001) published that paper, cardboard, coal and plastics had mean ash content of 20.2, 8.4, 5.7 and 0.4%, respectively. In a study conducted in Mexico, De Medina *et al.* (2013) established that ash content ranged between 18.6 and 11.1% which was considered optimal since it was lower than 50% where incineration techniques were possible.

d) Fixed carbon

The fixed carbon represented the solid carbon remnant in char after devolatilization process as noted by Oumarou *et al.* (2012) and Salami *et al.* (2011). Its determination is by removing moisture content, ash contents and volatile matter from the unit using Equation 2.1.

$$F_C = 100 - (M_C + V_M + A_S) \quad (2.3)$$

where F_C is fixed carbon, M_C is the total moisture content, V_M is the volatile matter and A_S is the ash content in percentage.

e) Calorific value

The calorific Value (CV) measured in units of energy per amount of material, joules per gram (J/g) is the heating value evolving substance/waste burned completely. The CV of samples can also be determined using a standard bomb calorimeter as specified by Oumarou *et al.* (2012). After drying and grounding samples of solid waste to small particles, they are sieved and then compressed forming pallets. The assembled bomb calorimeter is filled with oxygen at pressure of about 30 bars. The firing of bomb and after stabilization of temperature, the difference in values are recorded. In their findings Sørum *et al.* (2001) clarified that calorific value of plastics and paper/cardboard ranged from 40-50 MJ/kg and 19-17 MJ/kg, respectively. According to Rimaitytė *et al.* (2010), calorific value should not fall below 6.5 MJ/kg during wastes incineration otherwise, auxiliary fuel would be required in maintaining combustion.

2.3 Factors Influencing Performance and Emission Levels from Waste Incineration

The incineration performance and emission levels depend upon incinerator types, operating temperature levels, total time taken, turbulence of air/wastes and quality and quantity of flue gases emitted. The combustion objectives are organic constituent's complete destruction, formation of non-polluting gases and preventing the releasing of any harmful material into environment. According to Moora *et al.* (2012) and Botter *et al.* (2002), adequate time and high temperatures was highly required if solid wastes was to be burned completely. Moreover, Liamsanguan and Gheewala (2008) asserted that properly controlled incineration processes provided high combustion efficiencies and maintained low gas emissions. According to Manyele *et al.* (2011), Rufo and Rufo J (2004) and Würdemann and Van-Veen (2002), the stack gas pressure must carefully be controlled to ensure removal of all flue gases at correct rate from combustion zone. Emission rates and exposures may be elevated due to use of waste with high MC ; overloading of incinerators; low operating temperatures; poor design and siting; and lack of emission limits, inspection and monitoring as emphasized by Zhu *et al.* (2013).

2.3.1 Effects of moisture content on flue gas emissions

The moisture content (MC) of mixed solid garbage has less than 20% while food wastes ranged up to 80% as Chang *et al.* (2009) clarified. The reduction of MC during incineration would decrease smoke opacity hence, increasing the combustion efficiency as explicitized by Basham *et al.* (2004) and Government of Nunavut (2012). According to Dong *et al.* (2016), by increasing MC , simultaneously decreases the heating values, hence MC should be lowered to a

range from 20 to 25% to guarantee high incineration performance. In practice, the additional *MC* should be prevented by providing covers on disposal containers to avoid rain water and humidity since high *MC* or low calorific value leads to combustion irregularities. High *MC* can also be reduced by passing hot air into the wastes which in turn speed up drying process and improves gasification and vapourization stage as expressed by Quina *et al.* (2011) and Würdemann and Van-Veen (2002).

2.3.2 Influence of incinerator loading rate on flue gas emissions

The overloading of combustion chambers blocks air flow which further prevents flue gases and oxygen mixing reducing the turbulences leading to increased emission levels. Holding of solid wastes in position long enough during incineration and preventing smaller types from falling through grate without being destroyed are necessary measures. According to Basham *et al.* (2004), the correct amount of wastes loading should be two third (2/3) full. Incinerating wastes at designed loading rates enables to maintain desired operating temperatures and safeguards the equipment. Waste incineration with very high calorific values may leads into exceeding its thermal capacity, resulting into high temperatures, damaging refractory wall and excessive emissions as established by Government of Nunavut (2012). The operator should mix high, medium and low heating value of waste when sorting incinerator loads, to match the designed rate of heat released avoiding overloading beyond its intended use as expressed by Batterman (2004) and UNEP (2008).

2.3.3 Effects of incinerator operating temperature on emissions

The operating temperature is a function of waste heating value, designed incinerator unit, supplied air and combustion control. Temperature exceeding 750°C with residence time of two seconds, causes combustion completeness of most household and food waste as expressed by Neuwahl *et al.* (2019). The designed incinerators for complex solid waste mixtures, hazardous and biomedical wastes must have high operating temperatures of above 1000°C and least two seconds holding time, ensures combustion completeness and minimization of dioxin and furan emissions. High incineration temperatures above 1050°C would results into complete incineration of all organic materials, low carbon monoxide and hydrocarbon emissions in flue gases as described by UNEP (2019). Higher operating temperatures is important since it leads to high gas velocity, low residence time and improved combustion efficiency.

2.3.4 Assessment of smoke opacity at the chimney

Smoke opacity is the degree to which particulate emissions reduces the intensity of transmitted photopic light and obscure the view of an object through ambient air, effluent gas

stream of given path length. The smoke opacity of 5 to 100% and dark and dense particulate matter are illustrated in Plate 2.3.



Less than 5% Opacity

20-30% Opacity

90-100% Opacity

Plate 2.3: Dark and dense excessive particulate matter and low smoke opacity.

Source: Government of Nunavut (2012)

The fly ashes entrained in flue gases consists of small and light particulate matters (PM) which are mixed with used scrubbers sorbent and collected within air pollution control devices. The higher agitation caused by greater air flow would produce more fly ash in flue gases. According to Carson (2002), the presence of fly ash relates directly to the air turbulences and velocities in furnace chambers. Particulate matters of $PM_{2.5}$ comprises of carbon oxides, hydrogen halides, heavy metals, nitrogen oxides, sulphur oxides, dioxins and furans which must be reduced as emphasized by Bradfield (2014) and Würdemann and Van-Veen (2002). Additionally, Botter *et al.* (2002) emphasized that increase in particulate matter, PM_{10} in fly ash caused an increase of 1.2 to 2.3% in hospital admissions for pulmonary, heart and pneumonia diseases hence PM_{10} should be reduced in flue gaese.

According to Ujam and Eboh (2012), incinerating wastes containing high volatile matters including plastics, polythene papers and rubbers produces large tar quantities and heavy smoke. The Ringelmann developed graduated black grids charts on white background as shown in Figure 2.4 and was used to assess and control emissions as explicitized by Ashley (2013). When the charts is placed approximately 33 metres away, the grid appears as grey shades, hence quantifying emissions by comparing with the corresponding shade on the charts. The smoke opacity observer standing at a sufficient far distance for clear emissions viewing with sun orientation sector at 140 degree to his/her back.

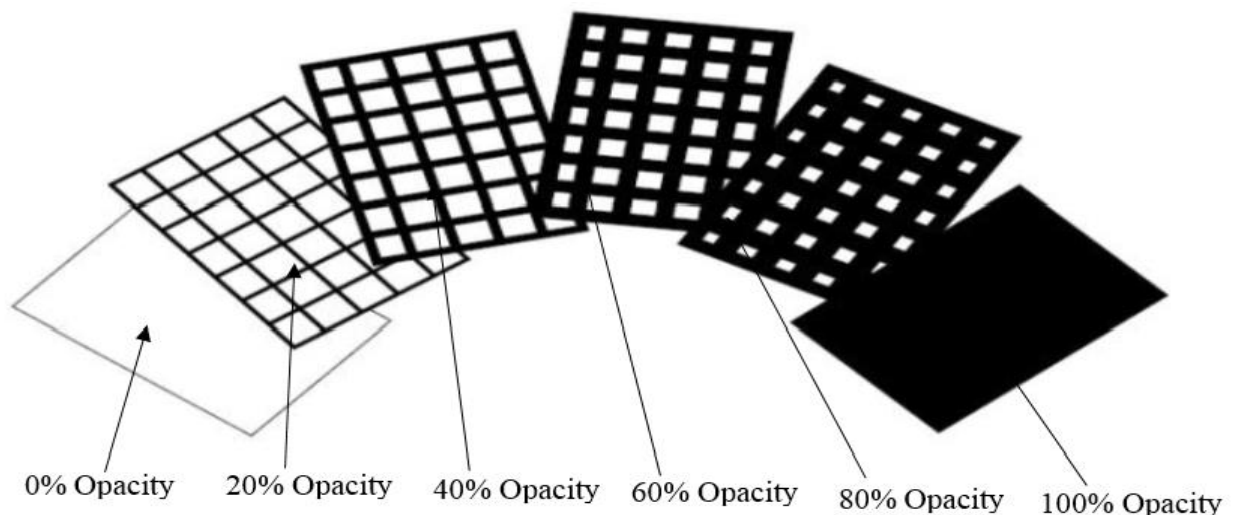

Figure 2.4: Ringelmann cards with graduated black grids on white backgrounds.
Source: Ashley (2013)

According to Government of Nunavut (2012) and Castellani *et al.* (2014) the stack smoke opacity should not exceed 5% since greater values indicates improper incineration performance and it requires evaluation and adjustments.

2.3.5 Assessment of bottom ash residues

The solid waste incineration residues consists of bottom ash, fly ash and other unburned particles and must properly be disposed of, forming part of integral sound waste management. When handling bottom ash, Wang *et al.* (2015) and Bradfield (2014) recommended that extreme care must be taken to avoid injury from contaminated sharp lancets, blades, broken glass items such as blood vial and Pasteur pipette, and others invasive instruments. The indiscriminate disposal of these residues can results into significant infectious risk to human and environment. The bottom ash residues accounting about 90% mostly consisting of heavy metals, silica, chlorine salt contents, alumina and iron oxides (Würdemann & Van-Veen, 2002). The hot bottom ash should completely be cooled before handling since its ember can cause very painful skin burn as also expressed by Tangri (2003) where workers are exposed sometimes with little or no protective gear. It also should not be buried or land filled when hot, since unburned wastes can catches fire in disposal area. Although bottom ash contains wide varieties of toxicity, Chang *et al.* (2009) and Carson (2002) established that the incineration residues is suitable for road constructions.

2.4 Air Flow Patterns and Velocity Simulations

The air flowing through combustion zones may cause increase in temperatures resulting into high burning rates due to excess oxygen supply as Ayaa *et al.* (2014) and Denda *et al.*

(2014) clarified. In their report Straka *et al.* (2018) used simulations to analyze, subsequent adjustment and improvement of wastes incineration processes in achieving the desired amount of heat energy for steam generation and emission pollutants reduction. During wastes incineration, CO passing through combustion region, would collide with hot gases and oxygen, converting it to CO_2 and further increasing temperatures. The temperature contours and carbon monoxide concentration simulations are presented in Figure 2.5.

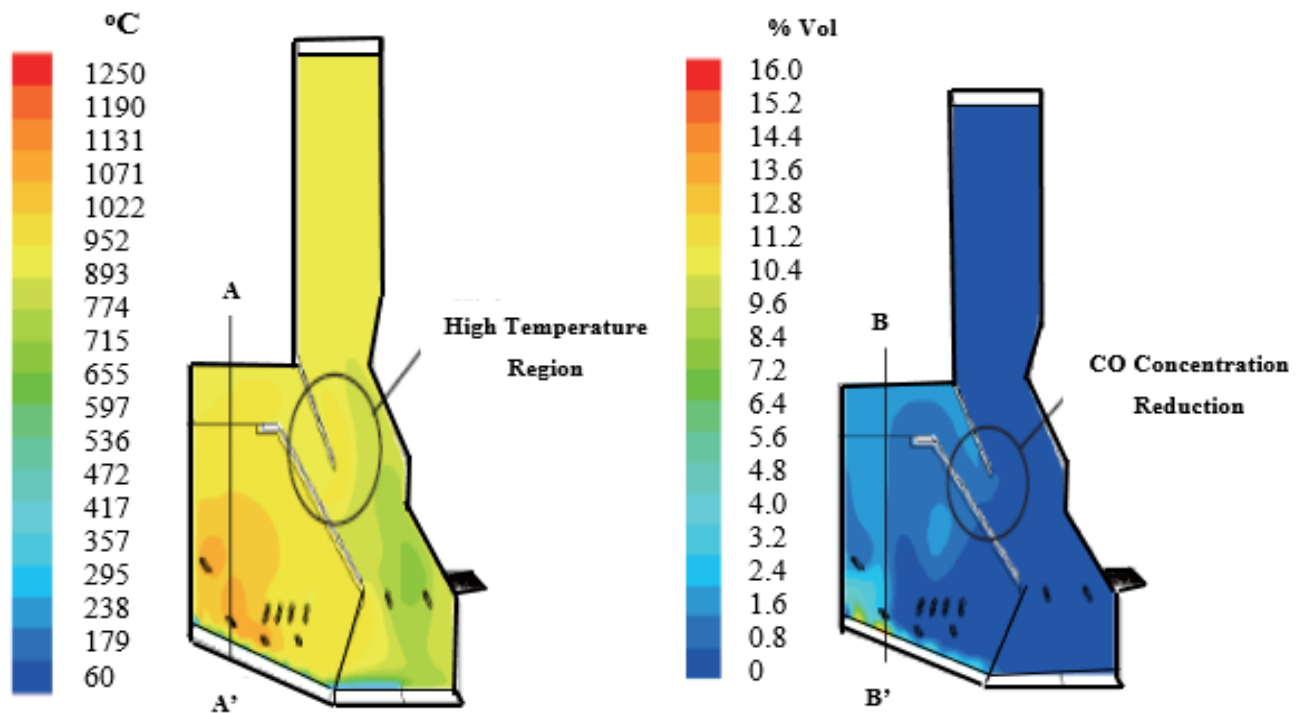

a) Temperature distribution contours

b) Carbon monoxide concentration distribution

Figure 2.5: Temperature and carbon monoxide concentration distribution

Source: Denda *et al.* (2014)

The simulations of air flow patterns and velocity profiles helps in visualizing the gaseous behaviour and solid flows within fixed bed including chemical reaction processes as Sun *et al.* (2015), Brosch *et al.* (2014) and Morrin *et al.* (2012) established. Also, Ryu *et al.* (2002) investigated propagation process reactions using wood as fuel in a fixed bed incinerator which included; air flow rate, moisture content, particle size, density, effects of wood on flame reaction rate and high temperature. The efforts Ryu made brought realization that highest propagation velocity was influenced by the relationship between air flow and turbulences. Moreover, incorporating the dome shaped deflector at air inlet port of incinerator designed models by Lin and Ma (2012) and Minutillo *et al.* (2009) contributed into better removal of all sudden contractions, enlargement points and smoothed walls.

2.4.1 Solid waste mass balance transport phenomena

The solid wastes incineration in combustion chamber at a certain residence time, exposes its surface areas to hot gases containing oxygen burning it completely as expressed by Gu *et al.* (2019) and Sun *et al.* (2015). The destruction rate of combustible waste fraction is evaluated in accordance to oxygen mass transfers from bulk gas phase to solid flame surfaces. The outlet solid waste flow rate, \dot{W}_{out}^s can be calculated by linking it to retention time and mass of holding up within the incinerator's as expressed by Mousavi *et al.* (2009) in Equation 2.4.

$$\dot{W}_{out}^s = \frac{m_{solid}}{\theta} = m_{solid} \frac{SDN}{1.77FL\sqrt{\beta}} \quad (2.4)$$

where, m_{solid} is mass of solid waste hold-up inside grate; θ is the retention time (second); β is the dynamic angle of repose for the solid material; F is the factor that related to internal area of incinerator; S is grate slope; N is rotational speed of gas; and D and L are internal diameter and length of combustion chamber, respectively. The rate of change of solid hold-up inside grate can be expressed by Gaurav and Khanam (2017) in Equation 2.5.

$$\frac{d(m_{solid})}{dt} = \dot{W}_{in}^{wst}(1 - \omega_{mc}) - R_{dr} - \dot{W}_{out}^s \quad (2.5)$$

where, \dot{W}_{in}^{wst} is inlet waste flow rate; ω_{mc} is the moisture content and R_{dr} is waste combustible fraction destroying rate and can be obtained from Equation 2.6.

$$R_{dr} = \frac{K_x(X_{bulk} - X_{int})M_{oxy} - C_{tot}}{\mu_{sc}} \cdot A \quad (2.6)$$

where, K_x is mass transfer coefficient; X_{bulk} is oxygen mole fraction in bulk of the gas phase, X_{int} is oxygen interface mole fraction; M_{oxy} is molecular weight of oxygen; C_{tot} is total concentration in gas phase; μ_{sc} is stoichiometric coefficient for waste combustion and A is interface area for oxygen contact. This area is a function of kiln geometry and operating conditions. Assuming complete waste destruction at steady state condition, solid phase balance, R_{dr} and A are specified by Gaska and Generowicz (2017) in Equation 2.7, 2.8 and 2.9.

$$\dot{W}_{out}^s = \dot{W}_{in}^{wst}(1 - \omega_{mc})(1 - \omega_{cf}) \quad (2.7)$$

$$R_{dr} = \dot{W}_{in}^{wst}(1 - \omega_{mc})\omega_{cf} = \frac{m_{solid}}{\theta} \cdot \left(\frac{\omega_{cf}}{1 - \omega_{cf}} \right) \quad (2.8)$$

$$A = \frac{\mu_{oxy}}{k_x C_{tot} M_{oxy}} \cdot \left(\frac{\omega_{cf}}{1 - \omega_{cf}} \right) \quad (2.9)$$

The feedstocks consisting of dry solid fractions $(1 - \omega_{mc})$ and moisture fractions ω_{mc} within dry solid. The stoichiometry constituting of combustible solid waste fractions ω_{cf} to accounts for heterogeneous combustions.

2.4.2 Gas-phase balances transport phenomena

The reactions in the furnaces including the loading rates and temperature levels are functions of overall wastes combustion destructions. Taking into account the auxiliary fuel where gas-phase balance total is expressed by Mousavi *et al.* (2009) in Equation 2.10.

$$\frac{d(m_{gas})}{dt} = \dot{W}_{in}^a \cdot \omega_{nt}^a + \dot{W}_{in}^a \cdot \omega_{ox}^a + (1 - \mu_{ox})R_{dr} + \dot{W}_{in}^f - \dot{W}_{out}^g + \dot{W}_{in}^{wst} \cdot \omega_{mc} \quad (2.10)$$

where m_{gas} is gas hold-up inside the kiln; \dot{W}_{in}^a is inlet air flow rate; ω_{nt}^a is mass fraction of nitrogen in air; ω_{ox}^a is mass fraction of oxygen in air; \dot{W}_{in}^f is auxiliary fuel flow rate and \dot{W}_{in}^{wst} is outlet gas flow rate, respectively as emphasized by Denda *et al.* (2014). The corresponding mass balances are specified by Equation 2.11.

$$\frac{dM_i}{dt} = \dot{W}_{in}^a - \frac{\dot{W}_{out}^g}{\sum_i M_i y_i} \cdot y_i + R_i V_{tot} \quad (2.11)$$

where \dot{W}_i is inlet gas flow rate of component; R_i is production/consumption rate for reactions in kinetic regime; V_{tot} is combustion chamber volume and V_i is the gas mole fraction of species which is computed according to N'wuitcha *et al.* (2014) in Equation 2.12.

$$V_i = \frac{M_i}{\sum_i M_i} i = CO, CO_2, H_2O, SO_2, N_2, HC, HCl, NO, O_2, HBr, \frac{PCDD}{F}, \frac{PBDD}{F} \quad (2.12)$$

If the auxiliary fuels is required in maintaining operating temperatures, the reaction allow methane combustion process, taking into account available functioning of oxygen. The flue gases particulates relates directly to turbulences and velocities of air/gases in kilns.

2.5 Statistical Design and Experimental Analysis

Statistical analysis is the process of systematically applying logical techniques to collect, describe, illustrate, condense, recap, interpret and evaluate data in order to uncover patterns and trends. Descriptive analysis is the distribution of varying variables, entities and events to determine probabilistic or statistical relationships in quantitative manner and includes facts findings enquiries of distinct types (Douglas, 2013; Kothari, 2004). Moreover, multiple regression analysis is used where one dependent variable is a function of two or more independent variables and its objective is make prediction based on covariance. The analysis of variance (ANOVA) is a statistically measurement, describing the mean of squares deviating from samples mean of specified data series where this study used this type. The Chi-square (X^2) testing find its applications in large number of problems including testing suitability of quality; significance associated between two features; homogeneously of population variances as expressed by Oehlert (2010) in Equation 2.13.

$$X^2 = \frac{\sigma_s^2}{\sigma_p^2} (n - 1) \quad (2.13)$$

where σ_s^2 = samples variances; σ_p^2 = population variances; $(n - 1)$ = degrees of freedom, n = number of items in samples. The comparison of the calculated values with the tabulated table values of X^2 for $(n - 1)$ degrees of freedom at a given of significance test levels, may lead to either accepting or rejecting the null hypothesis. However, Least Significant Difference (*LSD*) is an extension of Student's t-test which uses a more comprehensive estimate of error in the data for making statistically valid mean comparisons as in Equation 2.14.

$$LSD = \frac{t(s\sqrt{2})}{\sqrt{n}} \quad (2.14)$$

where t = tabulated t -value at probability level ($P \leq 0.05$ for means with 95% accuracy); s = standard deviation of all plots; and n = number of measurements (observations) in each variety, usually equal to the number of replicates.

2.6 Compliance, Enforcement and Performance

The incinerators fugitive emissions and risk association may highly reduce the levels of standards/limits, operational controls and enhanced management practices as emphasized by Kim *et al.* (2009). Various countries in the world have established environmental monitoring agencies like the National Environment Management Authority (NEMA) in Kenya. *NEMA* regulates air quality by creating guidelines and enforcing existing safety controls published for application in residential and industrial environments. These regulations set limits of pollutants, review programs to aid improved performance and compliance of designs and ensure that acceptable equipment are constructed and utilized as recommended by Government of Nunavut (2012). The wastes open burning emits pollutants directly into the breathing zone of the atmosphere which affects health adversely and should be eliminated.

2.6.1 Incineration compliance

Compliance activity procedures are links to legislations, policy process outcomes, licensing or permitting, monitoring, enforcement, cycle closing with possible laws input for adjustments, assessment and feedback as reported by White and Heckenberg (2012). Its role includes checking compliance of incineration facilities against stated environmental laws, ordinances, regulations, agreements, directives, ministerial decrees and prohibitions. All pollution concentrations must be expressed at 0°C and 101.3 MN/m², dry gas at 11% oxygen correction as specified by Government of India (2009) and Rogers and Brent (2006). Compliance ensures adoption measures in achieving maximum waste reductions, applying of strict regulations and enforcement in regards to illegal garbage transportations with potentially environmental pollutions as Lorentsen and Burgeat (2004) expressed. Agencies conducts regular inspections on plant installations, operations and ensure adequate maintenance. Programs rolled includes

training, documentations, operators' certification and supervisory of personnel, inventory and record keeping besides tracking the utilization of incineration facility. The ambient air quality and incinerator design allowable limits is presented in Table 2.3.

Table 2.3: Ambient air quality and incinerator design allowable limits.

Pollutant	Time	Industrial	Residential,	Controlled	EU	USA
	averag	area	rural area	areas	mg/m³	mg/m³
Carbon monoxide	1 hr	10.0 mg/m ³	4.0 mg/m ³	2.0 mg/m ³	50-150	62-187
Carbon dioxide	1 hr	10.0%	4.0%	2.0%	-	-
Hydrocarbons	Instant	700 ppm	-	-	-	-
Volatile organic <i>VOC</i>	24 hr	600 µg/m ³	-	-	-	-
Ozone	8 hr	120 µg/m ³	1.25 ppm	-	-	-
Sulphur Oxides (SO _x)	Annual	80 µg/m ³	60 µg/m ³	15 µg/m ³	-	-
Nitrogen Oxides NO _x	Annual	80 µg/m ³	60 µg/m ³	15 µg/m ³	-	-
Nitrogen Dioxide	Annual	150 µg/m ³	0.05 ppm	-	-	-
Hydrogen Sulphide	24 hr	150 µg/m ³	-	-	-	-
Respirable particulate	Annual	70 µg/m ³	50 µg/m ³	50 µg/m ³	-	-
<i>PM</i> _{2.5}	Annual	35 µg/m ³	-	-	-	-
Lead	Annual	1.0 µg/Nm ³	0.75 µg/Nm ³	0.5 µg/Nm ³	-	-
Suspended particulate	Annual	360 µg/m ³	140 µg/m ³	70 µg/m ³	10	20
Operating temperature		Above 850°C	Above 800°C	Above 1050°C		
Stack height-3m above highest building		10 m above ground	10 m above ground	10 m above ground	-	-
Stoke opacity	8 hrs	> 20%	> 20%	> 20%	> 5%	> 10%
Lead (<i>Pb</i>)	Annual	1.0 µg/Nm ³	0.75 µg/Nm ³	0.5 µg/m ³	0.14	0.14
Dioxins and furans	6-8 hr average	0.1 ng TEQ/m ³	0.1 ng TEQ/m ³	0.1 ng TEQ/m ³	0.1 ng TEQ/m ³	0.2 ng TEQ/m ³

NB: One (1) mg/m³ is equivalent to one (1) ppm

Source: Environmental Management and Co-ordination Act- Kenya (1999)

Incinerator continuously monitoring are installed for measuring and recording parameters such as smoke opacity, oxygen, carbon monoxide, total hydrocarbons, hydrogen chloride, temperatures, particulate matter, gas flow velocity and quantity record keeping as Petridis and Dey (2018) explicitized.

2.6.2 Incineration enforcement

The Environmental Management and Co-ordination Act (EMCA) is an Act of parliament to provide for establishment of an appropriate legal and institutional backgrounds. According to Batterman (2004) the timelines are usually set for all existing incinerators to be fully compliance before any action is taken to demolish them. Moreover, local authorities mostly require health risk assessment for them to site and permit a facility. The enforcement actions must be strict and proportional to seriousness of laws breaching and environmental posed risks. It must also be swift and waver in order for offenders to returns to compliances as quickly as possible. Any person failing to comply with provisions of control order issued under environmental Act, commits an offence and shall be liable on conviction to a fine not exceeding one hundred thousand or imprisonment for a term not exceeding three years or both as reported by Environmental Management and Co-ordination Act- Kenya (1999).

The incinerators must ways be well maintained and in good working conditions in order to minimize emissions and a log book must be used to record all malfunctions and relevant authorities notified. The design of combustion chambers must provide residence time for gaseous of at least two second as per Neuwahl *et al.* (2019) guidance. According to Xin-gang *et al.* (2016), small scale incinerators appeared not to meet emission standards for CO, particulate matters, hydrogen chloride, dioxins, furans, heavy metals and other pollutants. The residence time can be calculated using Equation 2.15.

$$Residence\ Time = \frac{V}{Q_c} \quad 2.15$$

where V is the incinerator's volume in cubic metres (m^3), Q_c is the effective flue gas volumetric flow rate in cubic metres per second (m^3/s).

2.6.3 Incineration performance

The incineration performance measures comprises of the overall quality on how firmly inspections and enforcements monitors compliances and reduction of pollutants and risks. The ultimately goals for environmental qualities including inspections and enforcements action are most desirable measures of success. The best indicators of competence is the time law enforcement takes responding to violations, or achieves compliances as explicitized by White and Heckenberg (2012) and UNEP (2019). Combustion efficiency shall be at least 99.0% as recommended by Kenya Law Reports (2012).

2.6.4 Kyoto Protocol commitments and Stockholm Convention

The Kyoto Protocol operationalizes the United Nations Framework Convention on Climate Change by committing industrialized countries and economies in transition to limit and reduce

greenhouse gases (GHG) emissions in accordance with agreed individual targets. The Protocol asks those countries to adopt policies and measures on mitigation and report periodically. However, the Protocol also offers an additional means to meet their targets by three way of market based mechanisms: International Emissions Trading; Clean Development Mechanism; and Joint implementation. This had parallel benefits of stimulating green investment in developing countries and including private sector in endeavour to cut and hold steady *GHG* emissions at a safe level. It also frogged possibility of skipping the use of older, dirtier technology for newer, cleaner infrastructure and systems, with obvious longer-term benefits and more economical. The Protocol first commitment was that industrialized countries had to reduce gas emissions responsible for global warming by at least 5% compared to 1990 levels from year 2008 to 2012.

The Stockholm Convention on Persistent Organic Pollutants (POPs) is a global treaty to protect human health and environment from chemicals that remain intact for long periods. The exposure to *POPs* can lead to serious health effects including cancers, birth defects, dysfunctional immune and reproductive systems, susceptibility to disease and even diminished intelligence. The Stockholm Convention, requires the signatory and ratifying parties to take measures to eliminate or reduce the release of *POPs* into the environment. The Convention is administered by the United Nations Environment Programme (UNEP) which is based in Geneva, Switzerland.

2.6.5 The Environmental Management and Coordination Act

The Environmental Management and Co-Ordination Act (EMCA), Chapter 387 of 1999 laws of Kenya, determines appropriately the enforcements action, remedies and indicates who bears losses if accidental harm occurs to discourage violations and illegal conducts. The *EMCA* mechanisms are either civil or criminal actions where compensatory pay monetary penalties and injunctive, ordering activities to stop and repairing or cleaning up be completed. Some incineration laws includes: No owner or operator shall cause fugitive emissions to ambient air quality exceeding the limits; Operators shall ensure that exposure of workers is monitored and recorded; Licensee shall submit an emissions report to Authority within six months after the end of year as emphasized by Kenya Law Reports (2012).

The Environmental Impact Assessment (*EIA*) is a systematic examination conducted to determine whether or not a programme, activity or project will have any adverse impacts on environment. The *EIA* is required under the Act to conclude and approve all policies, plans, programme, projects and activities in accordance to regulations. The impacts include all relevant aspects of the natural, social, economic and human environment. The *EIA* also requires

a multi-disciplinary approach and should be done very early at the feasibility stage of a project. According to Kenya Law Reports (2012) regulations, no licensing authority in Kenya shall issue a trading, commercial or development permit for any project without approval of *EIA* issued by the Authority *NEMA*. The projects assessment should be carried out by *EIA* registered experts in accordance with the Act as explicitized by Corbitt (2004).

2.6.6 The National Environment Management Authority (NEMA)

The *NEMA* is government authority charged with general supervision and coordination policies implementation of all environmental matters in Kenya. *NEMA* was created by the *EMCA* that came into effect on the 14th of January, year 2000. The functions of *NEMA* includes: Promotes integration of environmental considerations into development actions with a view to ensuring proper management and rational utilization of resources on a sustainable yield basis for improvement of quality life; *NEMA* advises Government on legislative and other measures for implementation of relevant international conventions, treaties and agreements in the field of environment; It identifies development actions for audit and monitoring to be conducted under the Act; It prepare and issue annual report on state of environment and cooperates with relevant agencies on education and enhancement of public awareness on health and safety protections; It also initiate and evolve procedures and safeguards for prevention of accidents which may cause environmental degradation. *NEMA* encourages people to minimize pollutants by practicing composting, recycling, use green energy like solar, geothermal, wind turbine and planting trees to convert carbon dioxide into oxygen (NEMA Newsletter, 2019).

CHAPTER THREE

MATERIALS AND METHODS

3.1 The study Area and Materials Preparation

This research was conducted using eight (8) small-scale solid waste incinerators; one at Egerton University (Dispensary), four at Ng'onde (Janda Plaza, Neveah Court, Sajendu Hostel and Staller Plaza), two at Green Valley (Community Resource Centre and Neighbouring home) and one at Njokerio areas. It also included two muffle furnaces at the department of Animal Science Nutritional Laboratories between the months of May to September, 2015. The average ambient temperature ranged between 19 and 24°C. The map of Egerton University, Njokerio, Ng'onde and Green Valley areas including the incinerators locations is shown in Figure 3.1.

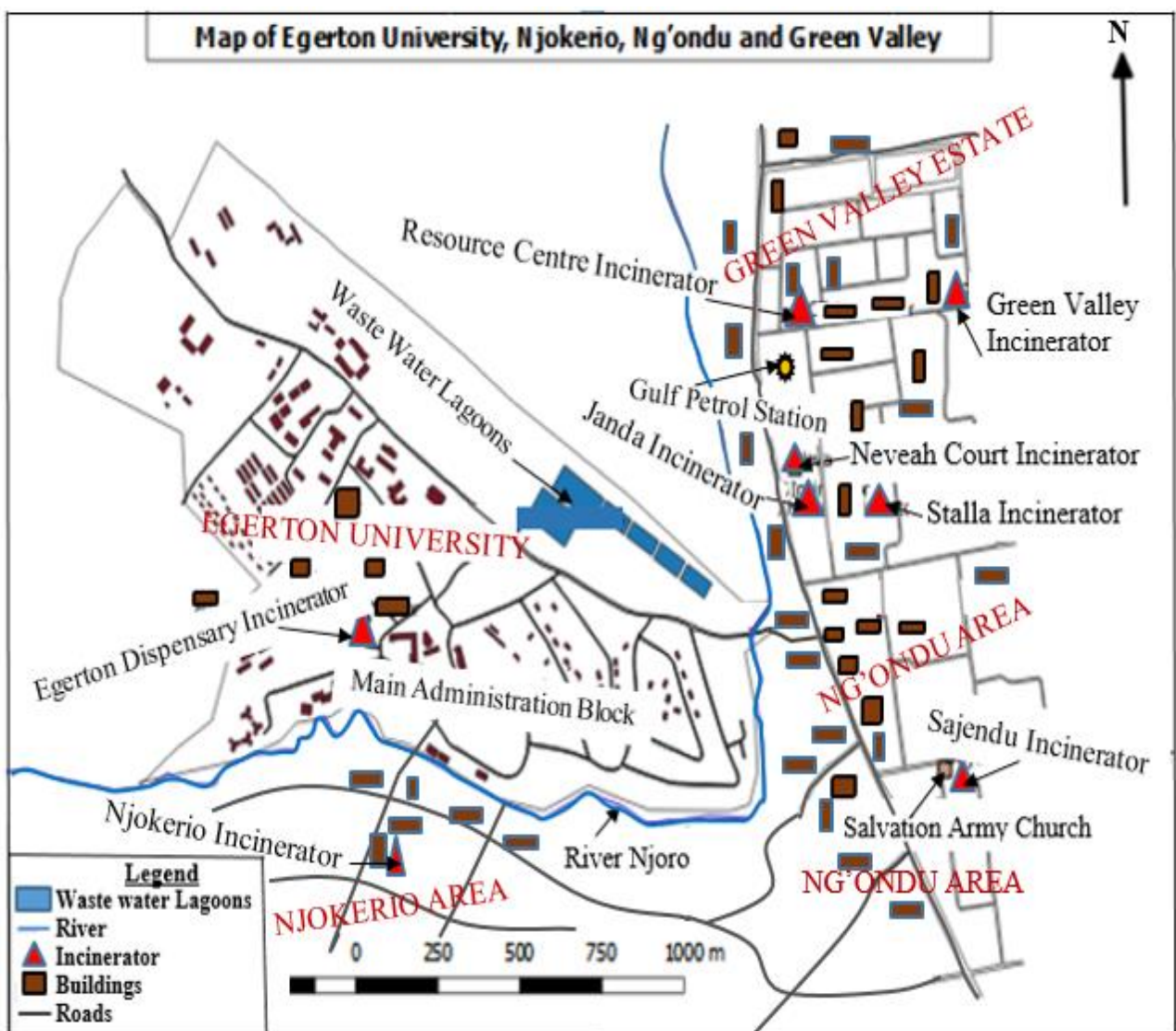

Figure 3.1: The study area

The collection of solid waste samples were from the Egerton University dump sites (student cafeterias, hostiles, departments of Crops, Horticulture and Soil, Animal Health, Human

Anatomy, Dispensary) and neighbouring residential areas (Njokerio, Ng'onde, and Green Valley). The wastes collected were sun dried for three days, chopped into small pieces and packed separately into waterproof containers in preparation for experimental processes. The wastes sizes reduction to less than one (1) mm was necessary in forming homogenous materials leading to increased surface areas hence allowing faster heat penetration. The waste samples loaded into incinerators were neither pre-treated nor specific ingredient selected. The weighing and recording of all waste samples was done before commencement of incineration processes.

3.1.1 Experimental set-up for the flue gases analyser

The equipment employed in this research included: flue gases analyser (*MS 805*); well-insulated muffle furnaces (*Lindberg/ Blue MBF51700*); digital electrical meter; electronic digital weighing balance; alternating current (*ac*) electrical power supply; air flow meter; solid waste vibrating/shaking machine; a laptop; and eight small-scale incinerators. Other facilities were driers, shearing/cutting machines, shovels, furnace crucibles, measuring instrument (tape measure) and timers plus materials such as nose masks, hand gloves and clear goggles. The flue gas analyser (*MS 805*) was configured to measure carbon dioxide (CO_2) and oxygen (O_2) depletion levels in percentage (%) while that of carbon monoxide (CO) and hydrocarbon (HC) in parts per million (ppm). The flue gas analyser, muffle furnace, electronic weighing machine and electrical meter experimental set-up is illustrated in Plate 3.1.

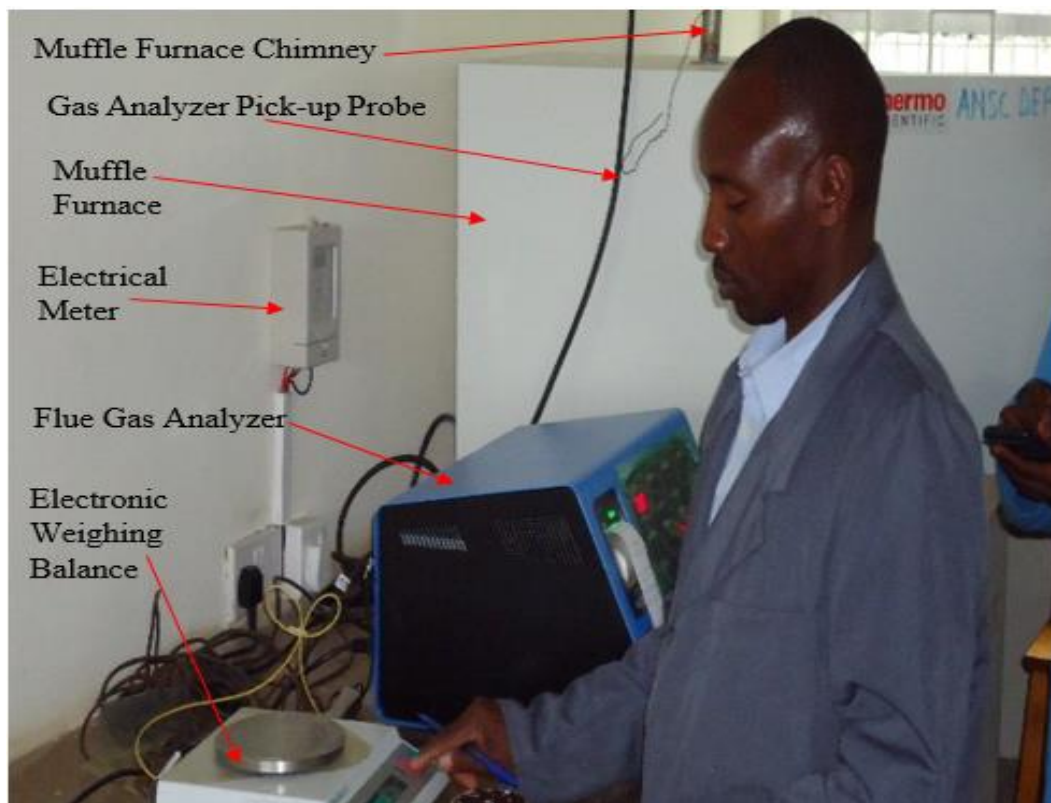

Plate 3.1: The experimental set-up for muffle furnace experiments.

The front and rear views of the flue gas analyser are shown in *Figures A1.1 and A1.2 in the Appendix*. The flue gases picking-up probes with hoses were firmly fixed to the chimney/stack of incinerators or muffle furnaces. The gas samples passed through probes of vertical position polymerized filters before reaching the steam trap cups at the bottom of gas analyser. When flue gases reached the trap base ducts, branching into three different pipes where first fittings was into vacuum sensors detecting any possibility of anomalies in gases flowing or leaks in pneumatic circuits. The second pipe connects to sampled gases in ports which were discharged during emission levels calibrations and third pipe was connected to gas pumping side through a safety paper filters. The flue gas analyser had in-built internal measuring sensors for recording the emission levels of CO_2 , O_2 , CO and HC via the metering bench before being purged out.

3.1.2 Muffle furnace incineration experimental set-up

The muffle furnace (*Lindberg/Blue MBF51700*) was used for wastes incineration at various operating temperature levels since temperature gauge could be regulated. The maximum energy efficiency of the muffle furnace was achieved by surrounding the chamber with thermal-efficient alumina fiber ceramic insulation. It was installed with three sides' resistance wire coil for the furnace uniform heating. It also had a heavy duty double layer structure with cooling fan to ensure low temperatures at outside casing. The muffle furnace incineration equipment with flue gas outlet and graph display is shown in Plate 3.2.

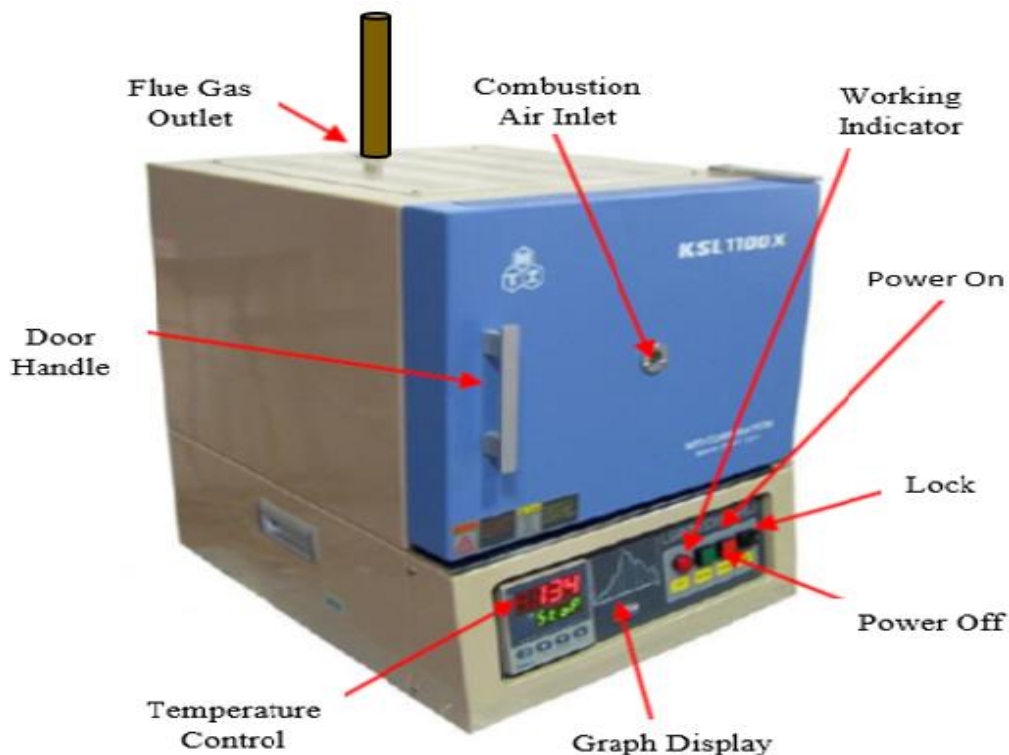

Plate 3.2: Muffle furnace incineration equipment.
Source: Nabertherm (2016)

The equipment was installed with a 12.5 mm diameter quartz glass observation window, allowing operators to view the inside chamber during incineration processes. It was also equipped with a thermocouple consisting of two wires of different metals for temperature controls and a combustion air inlet port for flow of fresh air. An empty crucible was weighed and solid waste samples weighing fifty gramme was poured into it then placed centrally in the combustion chamber and door closed. The muffle furnace power supply was switched on while flue gases vents were completely opened to fully remove the exhaust gases. The operating temperature knob was adjusted using enter/set arrow keys by pressing ‘on’ to register the changes. The electrical power ‘Run’ button was pressed on and the control panel started blinking commencing the operations. For safety, the incineration of inflammable, toxicity and carcinogenic waste materials were avoided. Also wastes with high concentrated sulphate, chloride, fluoride alkaline and other combustible substances were kept away due to their corrosiveness outcomes on ceramic fibers and explosiveness. All muffle furnace experiments took maximum time of 150 minutes and cool down of ten hours.

3.2 Characterization of the Solid Wastes

The solid waste characterization is the analysis of composition of waste stream, by material types and is important for effective long-term, waste management planning. The sorted and mixed wastes of various categories from the study areas are shown in Plate 3.2 and 3.3.



Plate 3.3: Sorted residential solid waste awaiting disposal at Stalla residential.



Plate 3.4: Mixed solid waste with high levels of polythene bags at Njokerio dump site.

The factors influencing solid waste characterization includes the degree of urbanization and industrialization, social customs, per capita income, geology, geography and climate change. The waste quantities help in calculating size of disposal facilities, such as incinerators, landfills and recycling equipment. The solid wastes with high proportions of polythene papers, plastics papers, photocopying papers and charcoal dust, food remains among other deposits in the dumpsites are exhibited in *Plate A1.1 in the Appendix*. The solid waste samples from those dumpsites were sorted out manually, weighed and placed into polythene bags and the percentages components determined through characterization. Solid wastes were purposively categorised into physical and combustion type in order to determine its composition which included density, moisture contents, volatile matters, fixed carbon, ash contents and calorific value. To produce garbage with low moisture content and ensure sustainability of combustion, solid wastes were sun dried for two more days as recommended by Chen *et al.* (2014) and Astrup *et al.* (2011).

3.2.1 Physical characterization of solid waste

The physical characterization of solid wastes comprised of moisture contents and densities. The moisture content was expressed as percentage per materials weight while density was expressed as mass per unit volume. The experiments were replicated thrice and the raw data results for solid wastes characterization are presented in *Table A2.1 and in the Appendix*.

a) Moisture content

The moisture contents (MC) was determined using *ASTM E871-82* (2013) standards. An empty container was preheated for twenty minutes to remove any traces of moisture/vapour and a fifty gramme of wastes sample poured into it. The container and sample were placed into a furnace at 105°C for twelve hours then cooled to 23°C , the room temperature and weight recorded. The moisture content M_C of the sample in percentage (%) was determined using Equation 3.1.

$$M_C = \left\{ \frac{A-B}{A} \right\} \times 100\% \quad (3.1)$$

where, A is the weight of wastes sampled before heating in gramme (g) and B is the weight of wastes sampled after heating in gramme (g).

b) Density

The density of solid wastes was determined by first weighing an empty container of known volume (V_1) and recording it as M_1 . The shaking/vibrating machine was used to settle and compact waste material samples into the containers. The container was firmly clamped into vibrating platform of the shaking machine. The shaking machine speed was set at 300 rpm for uniformity of solid waste quantity as per the requirements. The waste samples were poured into container, machine switched on and whole body vibrates for 10 minutes while topping up with remaining samples to filling up the created spaces. As the machine vibrates, it transmits energy to the container, forcing it to contract and settles wastes. The mass of container and its contents were recorded as M_2 after it was removed from the machine. If the sampled materials were insufficient in filling-up the vessel then, the volume (V_2) of partially filled-up vessel was measured and its mass and contents were recorded as M_3 . For the filled-up vessel, waste samples density in g/cm^3 was expressed using Equation 3.2 and later converted to kg/m^3 .

$$\text{Density} = \frac{M_2 - M_1}{V_1} \quad (3.2)$$

For a partially-filled vessel, the density was calculated using Equation 3.3.

$$\text{Density} = \frac{M_3 - M_1}{V_1 - V_2} \quad (3.3)$$

3.2.2 Characterization of solid waste by combustion

The solid wastes characterization by combustion processes was done to estimate its heating value by determining composition in terms of volatile matters, ash contents, fixed carbon and calorific values. The waste characteristics raw data are presented in *Table A2.1 in the Appendix*. The combustion process is very complex, involving simultaneous coupled heat energy released

through oxidation and chemical reactions, mass transfer and fluid flows expressed using Equation 3.4 as denoted by Quina *et al.* (2011).

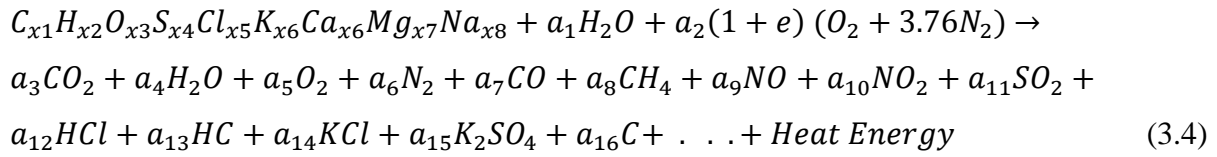

where a_1 corresponds to moisture in the wastes; a_2 relates to air (mixtures of O_2 and N_2); $1 + e$ is excess air associated to stoichiometric ratios, usually ranged between 1.2 and 2.5; a_3 to a_{16} corresponds to coefficients of different species found as reaction products.

a) Volatile matter

The volatile matter was determined using the *ASTM E872-82* (2013) standards. A fifty gramme sample of solid wastes was placed into crucibles with lids and their weight recorded. The covering of crucible was done to avoid contact with air during the devolatilizing processes. The crucibles containing samples were placed centrally in the muffle furnace, electric power supply switched ‘on’ and temperatures maintained at 950°C for ten minutes. It was then switched ‘off’ and cooled down to 23°C. The crucibles and covers without disturbance were weighed and recorded. The volatile matters, V_M in percentage is estimated using Equation 3.5.

$$V_M = \left\{ \frac{C-D}{C} \times 100 \right\} - M_C \quad (3.5)$$

where, C is the weight of waste sample before heating in (g), D is weight of waste sample after heating in gramme, and M_C is moisture content calculated in Equation 3.1.

b) Ash content

The ash content was determined using the *ASTM E1534-93* (2013) standards. A fifty gramme of solid wastes sample was put into a weighed and uncovered crucible and placed centrally into muffle furnace chamber. The electric power supply to the furnace was switched on and temperature maintained at 725°C for one hour then switched off. The crucible with its contents were removed after cool down to 23°C and their weight recorded. The Ash content, A_S expressed in percentage is determined using Equation 3.6.

$$A_S = \left\{ \frac{E-F}{E} \right\} \times 100\% \quad (3.6)$$

where, E is weight of solid waste sample before heating; and F is weight of solid wastes sample after heating (inclusive of moisture contents).

c) Fixed carbon

The fixed carbon which indicates the proportions of char remaining after the devitalization phases, was determined by subtracting the sum of moisture content, ash content and volatile

matter from one unit or one hundred (100) percent. Fixed carbon, F_C content given in percentage is calculated using Equation 3.7.

$$F_C = 100 - (M_C + V_M + A_S) \quad (3.7)$$

where, M_C is total moisture contents, V_M is volatile matters, and A_S is ash contents, all in percentage (%).

d) Calorific value

The calorific values (CV) of solid wastes samples was determined based on the *ASTM D240-02* (2013) standards, using combustion processes calorimeter type (*Auto bomb type-E2K*). The waste samples were dried and ground into small particles which were later sieved and compressed to form pellets. A reaction vessel holding the waste samples was supplied with oxygen at pressure of 30 bars and immersed into water bath at 23°C ambient temperature. The testing of firing circuits and calorimeter adjustments was done and weighing of enough water into vessel for complete submerging of the bomb. The energy discharged by complete incineration of reactants within the vessel was absorbed by water bath causing temperatures rise in the water jackets. A pure compound of benzoic acid was incinerated in order to acquire a thermal response of the equipment to a particular heat energy released. During the experiments, the water equivalence, W was calculated using benzoic acid and its value determined using Equation 3.8.

$$W = \frac{(H_{OB} \times M_B) + Q_N + Q_Z}{\Delta T} \quad (3.8)$$

where, H_{OB} is reference substance calorific value; M_B is the substance weight; Q_N is sulphuric acid correction of formation; Q_Z is sum of all extraneous quantities; and ΔT is temperature rise (°C). Using the standard bomb calorimeter, the waste samples heat energy values (HV_C) in kilojoule per kilogram (kJ/kg) is determined using Equation 3.9.

$$HV_C = \frac{W(\Delta T - E_1 - E_2 - E_3 - E_4)}{m} \quad (3.9)$$

where, W is water equivalent ($KJ^\circ C$); E_1 is correctional heating formations of nitric acid; E_2 is correctional heat formations of sulfuric acid; E_3 is correctional incineration of gelatinize capsule used with liquid testing; E_4 is correctional heating value for incineration firing wires; and m is weight of the sample (g).

The parts of standard calorimeter includes a bomb or vessel where combustible substance are burned, bucket or container for holding bomb in a measured quantity of water and stirring mechanism. Other parts include insulating jacket to protect bucket from transient thermal

stresses during combustion processes, and thermometer for measuring temperature changes within the bucket. The parts of the standard bomb calorimeter is shown in Figure 3.2.

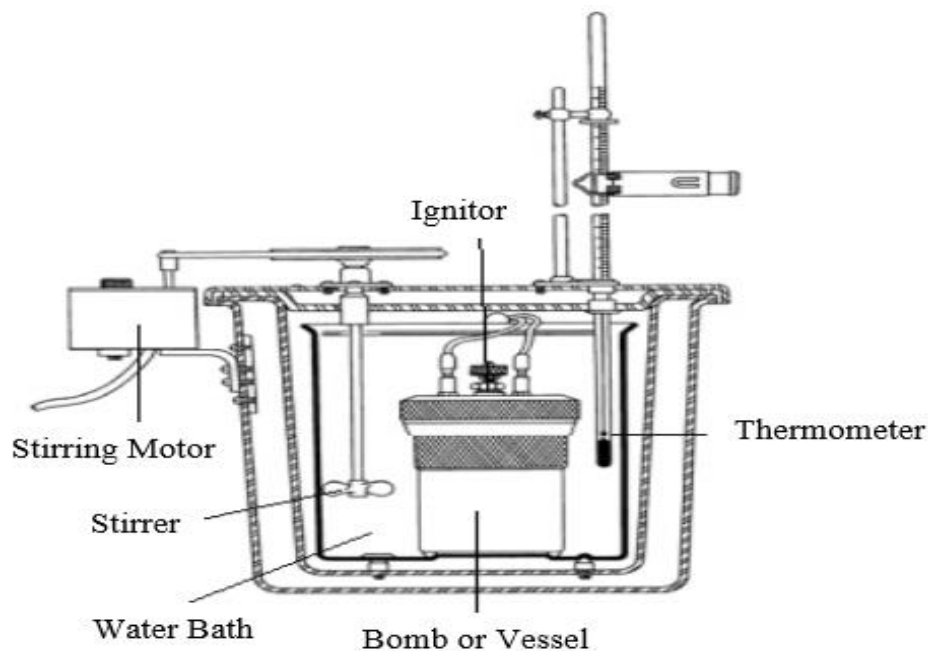

Figure 3.2: Diagram of a standard bomb calorimeter.

Source: Parr (2010)

The bomb must be strong, thick-walled metallic vessel to withstand high pressures and can be opened for inserting samples, removing combustion products and when cleaning. The valves are provided for filling bomb with oxygen under pressure and for releasing residual gases after experiments. The calorimeter also has electrodes for carrying an ignition current to a fuse wire.

3.3 Factors Influencing Solid Waste Incineration Performance on Gas Emissions

The solid waste incineration experiments at varying moisture contents and incinerator loading rates were carried out using small-scale incinerators while that of varying operating temperature levels were carried out on a laboratory scale using muffle furnaces. The maximum time of 150 minutes for each experiment was adopted for all muffle furnaces and small-scale incinerators. According to Park *et al.* (2013), solid wastes incineration processes was regarded complete upon achieving an oxygen concentration levels of greater than 20.61% in flue gases. All experiments were replicated thrice with emissions raw data tabulated in tables, smoke opacity assessments were done and photographs taken while bottom ash residues was removed and packed for analyses. The experiments were carried out using the four working incinerators at Egerton University, Community Resource Centre, Janda Plaza and Green Valley residential home which were different in sizes, capacity and output were located at different areas. The

small-scale incinerator at Janda Plaza opposite the Njoro canning factory where some of the experiments were conducted is shown in Figure 3.3 and units were in metres.

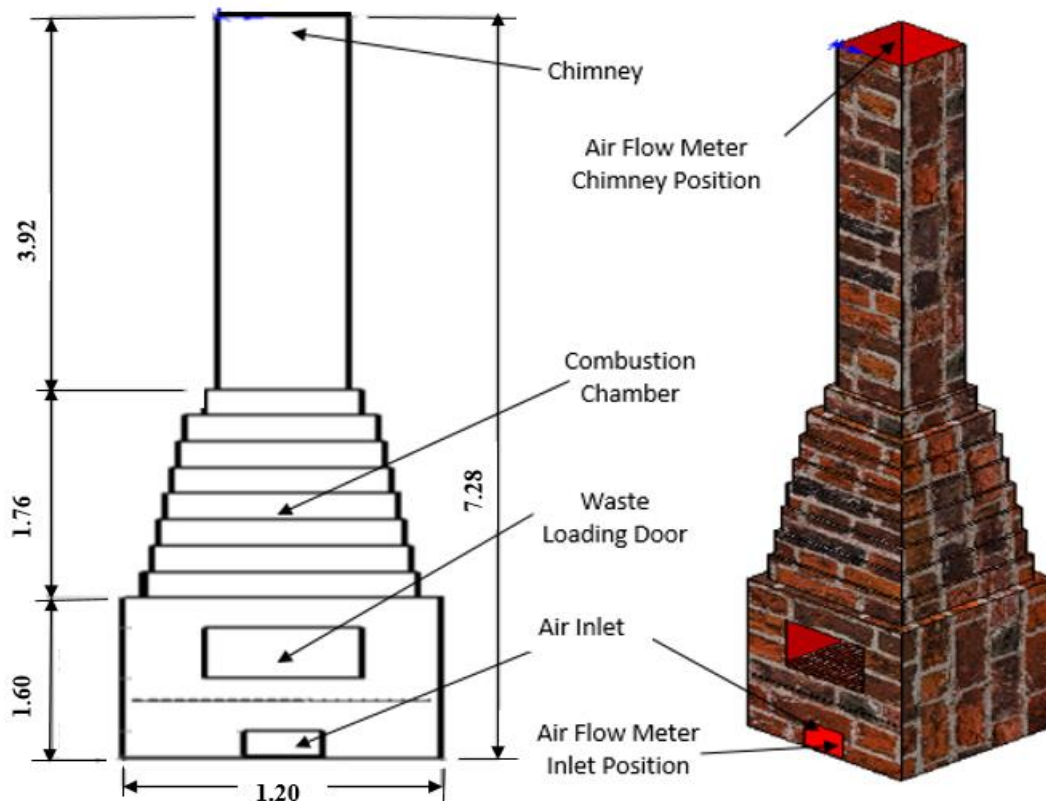

Figure 3.3: Small-scale residential solid waste incinerator at Janda Plaza.

The design and operations of other four incinerators including Neveah Court, Sajendu hostel, Njokerio were defective forcing operators to practice open burning outside the facilities while Stalla was under construction. The incinerators were all loaded with thoroughly mixed similar solid waste from each estate at a time.

3.3.1 Effects of waste incineration at varying moisture contents on gas emissions

The effects of solid waste incineration at varying moisture contents (MC) on flue gas emission levels were investigated by increasing *MC* from 15 through 75% at intervals of 15 %. These arrangements compared well with range from 16 to 75% as employed by Katiyar *et al.* (2013) and between 16 and 41.9% as published by Miezah *et al.* (2015). The different moisture contents were obtained by rewetting and drying of the solid wastes samples. Triplicate samples of wastes were constantly dried in ovens at 105°C for twelve hours then cooling done in desiccators and their weights recorded. The waste samples of different moisture contents were thoroughly mixed and separately loaded into the incinerator and furnace ignited. The gas analyser was set to print out results after two minutes of carbon monoxide, carbon dioxide and hydrocarbon emissions quantities as the flue gases passed through the machine and records

kept for further analyses. The same procedures were repeated for the other moisture content levels. The raw data from solid wastes incineration at varying moisture contents is presented in *Table A2.2, A2.3 and A2.4 in the Appendix.*

3.3.2 Influence of waste incineration at varying loading rates on gas emissions

The effects of solid waste incineration at varying loading rates of 15, 30, 45, 60 and 75 kg/h, experiments was performed using Janda plaza incinerator as shown in Figure 3.3. The incinerator had a normal solid wastes loading capacity was 45 kg/h. Waste samples of low, medium and high heating values were thoroughly mixed to emulate the normal incinerator loading before being used. Since solid wastes loading of incinerators was manual, then it was done when cold. The closing of incinerator doors was important in preventing air infiltrations into the combustion chambers. The gas analyser picking-up probe with their hoses were firmly fixed at the chimney and the power supply switched on. During wastes incineration, emission levels of carbon monoxide, carbon dioxide and hydrocarbon and oxygen depletions levels for each experiment were recorded, smoke opacity assessment and photographs taken for analyses. The bottom ashes was removed after cool down to 23°C and packed in well labelled separate bags for further analyses. The raw data of solid wastes incineration at varying loading rates are presented in *Table A2.5, A2.6 and A2.7 in Appendix.*

3.3.3 Effects of waste incineration at varying operating temperatures on emissions

The experiments on effects of wastes incineration at varying operating temperature levels on flue gas emissions were carried out using well-insulated muffle furnace (*Lindberg/Blue MBF51700*) where its temperature gauge could be adjusted. The solid wastes incineration was done at varying operating temperature levels from 180°C through 900°C at intervals of 180°C. These process compared well with range from 25 to 1025°C as expressed by Bradfield (2014). A fifty (50) gramme solid wastes sample in a crucible was placed centrally into the furnace and door closed. The gas picking-up probe and its hoses were firmly fixed at the stack and muffle furnace and gas analyser switched on. As flue gases passed through gas analyser, the emission levels of *CO*, *CO₂* and *HC* were recorded and smoke opacity assessed. The bottom ash was packed into well labelled waterproof containers for further analyses. The raw data from solid wastes incineration at varying operating temperature levels are presented in *Table A2.8, A2.9 and A2.10 in Appendix.*

3.3.4 Assessment of smoke opacity at the chimney

The assessment of flue gases smoke opacity was achieved by observing and noting the chimney emissions when incinerating solid wastes at varying moisture contents, incinerator

loading rates and at operating temperature levels specified in the foregoing sections. The Ringelmann charts was placed approximately 33 metres away, the grid appeared as grey shades, hence quantifying emissions by comparing with the corresponding shade on the charts in *Figure 2.4 in Chapter Two*. The smoke opacity observer stood at sufficient far distance for clear emission viewing with the sun orientation sector at 140 degree to his/her back. The smoke opacity comparisons between dark and dense smoke with excessively particulate matters and light and clear smoke was presented in *Plate 4.3 and 4.4 in Chapter Four*.

3.3.5 Assessment of bottom ash residues

The incinerators starting-up commenced with removal of bottom ash residues from previous operational cycles. The incinerators were cooled down for ten hours after end of each experimental cycle for safely and efficiently removal of bottom ash. The flat blunt shovels were used for cleaning-up, contrary to sharp objects, to avoid damaging the refractory materials. The dropping of generated ash residues through metallic grills/grates into ash containers at bottom of furnace was done using mechanically operated stirrers. The ultimate steps in process was examining bottom ashes qualities for unburned materials like papers, plastics, woods, food scrapes and appearances including colours and sizes which was an indication of incineration performance. The bottom ash from different incineration processes was presented in *Figures 4.10 in Chapter Four*. The weight of collected bottom ashes (W_{as}) at stop of every incineration processes was compared with total wastes loaded (W_t). The wastes combustion processes lost weights (W_r) are calculated using Equation 3.10.

$$W_r = W_t - W_{as} \quad (3.10)$$

The percent weight reduction, P_{wr} , was determined using Equation 3.11.

$$P_{wr} = \frac{W_t - W_{as}}{W_t} \times 100 \quad (3.11)$$

3.4 Simulation of Air Flow Patterns and Velocity Profiles for Small-Scale Incinerators

The air flow patterns and velocities profiles were simulated for small-scale incinerators located at Janda Plaza, Green Valley residential home, and Community Resource Centre and their performances compared with that of Egerton University dispensary. During experiments, the air flow was assumed to be steady and compressible with variable fluid properties, while gases flow was turbulent and instantaneous. The actual dimensions of the existing incinerators were used in the design, drawing and the simulations. The models were designed with equal dimensions for air inlet port, combustion chamber's volume, chimney height, loading door and grate height and sizes. The modelled designs was optimized to suit the existing solid waste incineration processes as emphasized by Sun *et al.* (2015), Yang *et al.* (2004) and Ryu *et al.*

(2002). The air-flow measurements were taken at inlet and exit of the chimney using air flow meter as illustrated in *Plate A1.4 in the Appendix* and results compared with simulation outputs.

The Egerton University dispensary incinerator, though old had some features which were incorporated in re-designing to improve performance of others, which included venture-meter curves, inlet air ventilation and its proportionality. The incinerators in the study areas were permanently stones built hence, square, rectangular, circular and triangular base-shaped models were adopted with equal capacity taking into account that of Egerton University dispensary. According to Gaska and Generowicz (2017) and Chanson (2009), particle velocity calculation and burner end were the main factors considered in simulation of waste combustion processes. The particle velocity was calculated using Euler-Euler model in *COMSOL* software. The space occupied by each phase was given by phase volume fraction r , (x, y, z and t), as established by Pushpendra and Srivastava (2017) and Gu *et al.* (2019) in conservation Equation 3.12.

$$\frac{d}{dt}(r_i p_i) + \nabla(r_i p_i v_i) = 0 \quad (3.12)$$

where $\nabla = del$ operator for outer product tensor of the vector field; $i = particle (s)/(r_g + r_s)$; $p_i = pressure (Pa)$; r_i is the particle radius (m). The transportation equation was computed using Equation 3.13.

$$\frac{\partial}{\partial t}(r_i p_i v_i) + \nabla(r_i p_i v_i v_i) = -r_i \nabla_p + \nabla \cdot (r_i \tau_i) + r_i \rho_i g - \beta_v \quad (3.13)$$

where $\rho_i = density (kg/m^3)$; $v = velocity (m/s)$; $\beta_v =$ Surface tension force (N); $g =$ gravity acceleration (m/s^2) and $\tau_i =$ viscous stress tensor (kg/ms^2) where both phases was modelled by the Newtonian strain-stress relation using Equation 3.14.

$$\tau_i = \zeta_i (\nabla \cdot v_i) I + \mu_i [\nabla v_i + (\nabla v_i)^T] - \frac{2}{3} \mu_i (\nabla \cdot v_i) I \quad (3.14)$$

where $I = unit\ tensor$; $\zeta_i =$ Bulk viscosity of phase (kg/ms); $\mu =$ dynamic viscosity (Pas)
The Non-Newtonian properties of particulates phases taking into accounts modelled particles viscosities. The bulk viscosity, ζ_i setting was zero in both phases. The turbulence model was useful for prediction of the mean velocity flow (\vec{v}) profile for steady state Equation 3.15.

$$(\vec{v} \cdot \vec{\nabla}) \vec{v} = -\frac{1}{\rho} \vec{\nabla} P + \nu \vec{\nabla} \vec{v} + \vec{f} \quad (3.15)$$

where P is the static pressure, \vec{f} is the shear force called shear tensor. The eddy viscosity μ_T for turbulence kinetic energy Equation 3.16 and energy dissipation rate Equation 3.17 and 3.18.

$$\mu_T = \rho C_\mu \frac{k^2}{\varepsilon} \quad (3.16)$$

$$\rho(\bar{u} \cdot \nabla) K = \nabla \cdot \left[\left(\mu + \frac{\mu_t}{\sigma_k} \right) \nabla K \right] + P_k - \rho \varepsilon \quad (3.17)$$

$$P(\bar{u} \cdot \nabla) \varepsilon = \nabla \cdot \left[\left(\mu + \frac{\mu_t}{\sigma_\varepsilon} \right) \nabla \varepsilon \right] + C_{\varepsilon 1} \frac{\varepsilon}{K} P_k - C_{\varepsilon 2} \rho \cdot \frac{\varepsilon^2}{K} \quad (3.18)$$

where $C_{\varepsilon 1}$, $C_{\varepsilon 2}$, σ_k , σ_ε and C_μ are turbulence model parameters; P_k is the production rate of turbulence kinetic energy; ε is turbulence dissipation; K is turbulence kinetic energy (J/kg).

During simulations and modeling of square, rectangular, circular and triangular base-shaped incinerators, the boundary conditions for pressure and air flow velocity at inlets and outlet were applied. The walls were treated at constant temperature. The incinerator geometries and operating conditions were used in developing models with variations from mean values in the boundary conditions as expressed by Huai *et al.* (2008). The combustion chambers and after-burning zones were designed to ensure long holding and reactions times of flue gases at higher temperature levels as recommended by Musa *et al.* (2019). The initial boundary conditions included; air inlet density (ρ_o) = 1.292 kg/m³, inlet temperature (T_o) = 23 °C and atmospheric pressure (p_o) = 101,325 Pa.

3.5 Analysis of Data

The solid wastes characterization and incineration emissions data were subjected to Statistical Analysis of Systems (*software version 8.02*) for analysis. The means and standard deviations were obtained for waste incineration at varying moisture content, incinerator loading rates and operating temperature levels as presented in *Table A3.1 in the Appendix*. The results were subjected to Analysis of Variance (*ANOVA*) to examine whether there was significant differences in their means, Least Significance Difference performed at 5% significance level. Mean of each samples means, $\bar{\bar{X}}$ is calculated using Equation 3.19 as used by Douglas (2013).

$$\bar{\bar{X}} = \frac{\bar{X}_1 + \bar{X}_2 + \bar{X}_3 + \bar{X}_4 \dots + \bar{X}_K}{K} \quad (3.19)$$

where \bar{X} = mean of each sample and K = number of samples. The sum of squares for variance between (SS_{btwn}), sum of squares within (SS_{wthn}) and the total sum of squares for variance (SS_{total}) are expressed using Equations 3.20, 3.21 and 3.22 as noted by Kothari (2004).

$$SS_{btwn} = n_1(\bar{X}_1 + \bar{\bar{X}})^2 + n_2(\bar{X}_2 + \bar{\bar{X}})^2 + \dots + n_k(\bar{X}_k + \bar{\bar{X}})^2 = \sum \frac{(R_j)^2}{n_j} - \frac{T^2}{n} \quad (3.20)$$

$$SS_{wthn} = \left\{ \sum X_{ij}^2 - \frac{R^2}{n} \right\} - \left\{ \sum \frac{(R_j)^2}{n_j} - \frac{R^2}{n} \right\} = \sum X_{ij}^2 - \sum \frac{(R_j)^2}{n_j} \quad (3.21)$$

$$SS_{total} = \sum X_{ij}^2 - \frac{R^2}{n} \quad (3.22)$$

where $R = \sum X_{ij}$ the total values of individual items in all the samples; $i = 1, 2, 3, \dots$;

$j = 1, 2, 3, \dots$; $\frac{R^2}{n}$ = correction factor; and n = the number within samples. The mean square between samples (MS_{btwn}), mean square within samples (MS_{wthn}) and *F-Ratio* are expressed in Equation 3.23 and 3.24 as calculated by Oehlert (2010).

$$MS_{btwn} = \frac{SS_{btwn}}{(k-1)} \quad \text{and} \quad MS_{wthn} = \frac{SS_{wthn}}{(n-k)} \quad (3.23)$$

$$F\text{-Ratio} = \frac{MS_{btwn}}{MS_{wthn}} \quad (3.24)$$

The statistical outputs of Statistical Analysis of Systems (SAS) were summarized in various tables and graphs and observations were discussed in details in chapter four.

3.6 The Incineration Compliance, Enforcement and Performance

This section demonstrates the developed risk assessment methods based on specific regulatory standards/limits and performance indicators in use. The risk assessment outputs would be used to reflect efforts in regulation of individual processes and categories. The incineration compliance assurance programme would influence significantly the social value, effectiveness and the Government efforts in implementations of environmental policies and laws. The development and implementation of these management decisions would be based on identification of regulated community, adequate prioritization and precise rules of conduct and safety requirements.

3.6.1 Incineration Compliance Assurance

The incineration compliance comprises of determinations of facility status, description of all monitoring parameters, record keeping, reporting, test methods and continuous conformity with each applicable administrative requirements. Compliance rates rely on thoroughness and frequency of inspections and the accuracy of self-reported data. If not achieved, then a detailed information of how it would be executed, proposed remedial measures schedule taken, including sequence of actions leading to compliance. The incinerators auditing included the review of: quality and quantity of waste received and incinerated; prevention measures taken to reduce pollutants; assessment of operating records such as monitoring parameters; scheduled maintenance; ash quality, handling and disposal practices; and any complaints and incidences of unacceptable emissions. The smoke opacity emissions from incineration processes should not exceed 20% concentration limits recommended by Environmental Management and Co-ordination Act- Kenya (1999).

3.6.2 Incineration enforcement

The improved environmental quality including reduction of pollutants and health risks is the ultimate goal of any inspection and enforcement programme. The enforcement programme

includes: imposing a compliance schedules; temporarily or permanently shutting down part of an operation or entire facility; denying or revoking a permit; requiring a facility to clean up part of environment; emergency powers to enter and correct immediate dangers; and seek compensation for damage caused by violation. The mechanisms should be backed by law accompanied by procedural requirements to protect the rights of individuals. The penalties should be sufficiently serious and effective so that they do serve as a deterrent or to incapacitate the offender. The effectiveness of an enforcement strategy depends upon the tools used and time spent from detection until sanction against offenders. The incinerators operation was monitored using on-line instruments capable of continuously measuring stack emissions and combustion processes which including temperature range warning of failures in the system.

3.6.3 Incineration performance

The evaluations results are used as basis for identifying problem areas and making changes to improve the effectiveness. Another measure of performance is how well an inspection and enforcement programme monitors compliance while accountability ensures quality at all levels. The penalties indicator are also a measure of success. Periodic reporting of activities contributes to deterrence by raising awareness of violations identification and response. Mechanisms would be needed to gather and store data, and transfer it at appropriate intervals to other programme levels for analysis. The installed continuous monitoring and control systems indicates and confirm to good combustion processes and compliance with guideline limits, regulations and conditions of approval incorporated. The monitoring parameters comprises of: primary and secondary chambers exit temperatures; residual oxygen content of flue gases at exit; carbon monoxide, carbon dioxide and total hydrocarbons levels at exit; smoke opacity at the stack; and incinerator flue gas volumetric flowrate. The parameters are equipped with recording devices for subsequent reference and analysis.

CHAPTER FOUR

RESULTS AND DISCUSSION

This chapter discusses the results of solid wastes characterization; incineration emission levels; assessment of smoke opacity and bottom ash residues; air flow patterns, velocities profiles simulations and fluid dynamics modelling of small-scale incinerators. The graphs were generated from Statistical Analysis of Systems (SAS) results. The wastes characterization and incineration experiments were replicated thrice and graphs were discussed based on the means, standard deviation and Least Significant Different (LSD). The research investigated the effects of varying moisture contents, incinerator loading rates, and operating temperature levels on incinerator's performance by analyzing the emitted flue gases and bottom ash residues. The smoke opacity of flue gases were assessed and analysed. The observations made when conducting experiments are illustrated in *Plate A1.1 to Plate A1.4 in the Appendix*. The experiments raw data are explicitized in *Table A2.1 to Table A2.10 in the Appendix*. Analysis of Variance (ANOVA) results are presented in *Table A3.3 and A3.4* and critical values of *F*-Distribution at 5 percent level of significance in *Table A3.2 in the Appendix*.

4.1 Study Area Solid Waste Management and Incineration Facilities Design

The effects of poor solid waste management includes: littering of surroundings; impact on human health; disease-causing pests; environmental problems; soil and groundwater pollution; emission of toxic gases; and impact on land and aquatic animals. However, the treatment and disposal includes: recovery and recycling; sanitary landfill; composting; pyrolysis; and incineration. If incineration is chosen, equipment must be designed and sized accordingly to accommodate different waste types and quantity being produced. The incineration by products including toxic pollutants such as dioxin and furans which poses risks, affecting: workers and operators; local communities through inhalation and food consumption; regional and global through discharge of persistent chemicals.

4.1.1 Solid waste management

The solid waste management is a process accorded with best principles of public health, economics, engineering, conservation, aesthetics and other environmental considerations and that is responsive to public attitudes. Due to improper waste disposal systems, garbage heap up has become a menace while people clean their residence and working places, they litter their surroundings affecting environment and community as Pinasseau *et al.* (2018) noted. Exposure to improperly handled wastes may cause skin irritations, blood infections, reproductive issues, respiratory and growth problems. When garbage decomposes, it produces foul smell, and

become breeding ground for different types of disease-causing insects as well as infectious organisms. The on-site storage involves proper containerization to minimize these possible adverse effects as established by Corbitt (2004). The designed waste segregation system depends largely on active participation of the waste generators in various communities and how they comply with principles of sorting and separation of garbage as expressed by Miezah *et al.* (2015). The treatment and disposal is the last step in effective waste management and should be undertaken only after all other practical reduction and reuse options have been examined.

4.1.2 Incineration facilities design

Solid waste incineration is a thermo-decomposition treatment process where components present in garbage stream are ionized into harmless elements at higher temperature in presence of oxygen, reducing mass of materials from 80 to 85%, while volume between 95 and 96% (Niessen, 2010; Petridis & Dey, 2018). Combustion gas temperature, residence time, air supply and turbulence should be adequately and properly controlled to achieve the standards requirement (Corbitt, 2004). Consequently, open burning is still widely practiced in the study area leading to high emission levels, incomplete disinfection and destruction of wastes and increased community complaints (Batterman, 2004; Park *et al.*, 2013).

The design of incinerator should be provided with high degree of gas phase turbulence and mixing in combustion zone to ensure effective destruction of combustible substances in flue gases. This can be achieved through appropriate location of air jets, changes of gas flow direction, baffling, and constriction of cross sectional flow area. Some incinerators in the study area incorporated dome shaped at air inlet port and at chimney which led into improved combustion efficiency. Moisture condensation at flue gas cleaning systems reduces the overall plant life span, which can be avoided by incorporating use of corrosion resistant materials and special coatings in designs where it is prone to occur. Regardless of how well equipment is designed, wear and tear will lead to components deterioration, resultant decrease in combustion quality, increase in emissions, and potential risks to operators and public. The maintenance restores and increases the reliability, effectiveness and life of equipment. This process of restoration includes: Visual inspections for corrosion, leaks, mortar and seal failures; Testing of doors and other moving parts; and regular schedules, such as monthly to quarterly.

4.2 Characterization of the Solid Waste

The determination of solid wastes characterization is important in evaluations of systems, alternative equipment needs, management of programs and strategic planning. It also enhances the implementation of waste disposal, energy and resource options as expressed by Ansah

(2014), Aguilar-Virgen *et al.* (2010). The mean wastes characterization for the Analysis of Variance (ANOVA) results from Njokerio, Ng'onde, Green Valley and Egerton University areas are presented in the Table 4.1.

Table 4.1: Mean solid wastes characterization results from different areas.

Solid Waste Collection Areas	Moisture Content (%)	Volatile Matter (%)	Ash Content (%)	Fixed Carbon (%)	Density (kg/m ³)	Calorific Value (MJ/kg)
Njokerio Areas	51.29 ^a	23.87 ^a	17.82 ^a	7.02 ^a	307.64 ^a	4.96 ^a
Green Valley	39.74 ^b	34.86 ^b	15.59 ^b	10.01 ^b	251.83 ^b	6.27 ^a
Egerton University	27.56 ^c	46.63 ^c	10.06 ^c	15.75 ^c	185.52 ^c	15.87 ^b
Ng'onde Areas	45.71 ^b	27.53 ^a	16.37 ^a	10.39 ^b	284.34 ^a	12.53 ^c
Mean	41.08	33.22	14.96	10.79	257.33	9.91
LSD	6.0794	3.6832	1.5243	0.9674	23.4168	1.3212

NB: Wastes characterization mean followed by same letter superscript (a, b, c and d) in same column are not significantly different at $\alpha = 0.05$.

The sampled solid wastes varied according to commercial activities in the area, lifestyles, family economic status and the seasons of the year as expressed by Oumarou *et al.* (2012). The moisture contents, volatile matters and ash content from wastes characterization for Njokerio and Ng'onde were similar but their fixed carbon and densities differed slightly, whereas those from Green Valley and Egerton University were significantly different at $\alpha = 0.05$.

4.2.1 Moisture content

The solid wastes moisture content (MC) is an important characteristic since it influences the process of converting organic matters into composite and biogas, use of wastes as fuels and designing landfills or incineration plants as established by Miezah *et al.* (2015), Khamala and Alex (2013) and Ogwueleka (2009). Wastes from Njokerio had the highest MC of 51.3% while that from Egerton University which was mainly inorganic had the lowest MC of 27.6%. The wastes from Njokerio and Ng'onde were not significantly different but differed with those from Green Valley and Egerton University. The high moisture contents from Njokerio area were due to higher percentages of organic matters (leftover food), ash residues from cafeterias and vegetable garbage from market places. The mean MC calculated *F-value* of 57.6 in Table A3.3 (i) in the Appendix was higher than critical value of 4.07 and the respective probability of 0.056 was greater than $\alpha = 0.05$ with Least Significant Difference (LSD) of 6.094 percent. This implies that solid wastes from Njokerio, Ng'onde and Green Valley differed significantly as

compared with Egerton University. The means solid wastes moisture contents characterization results from various areas are given in Figure 4.1.

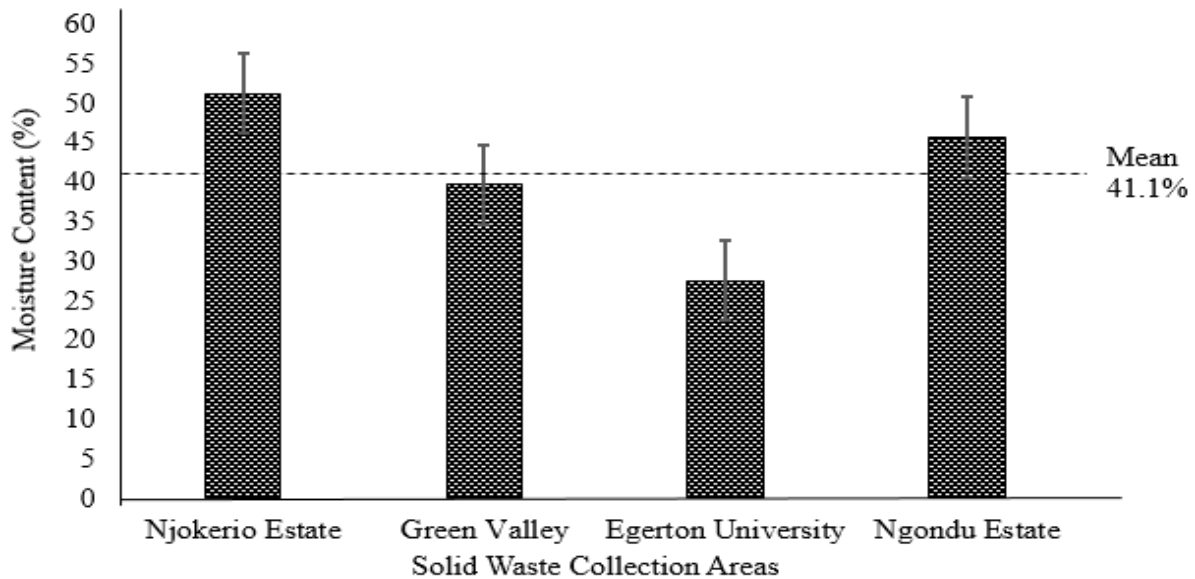

Figure 4.1: Moisture content mean wastes characterization from different areas.

The wastes from Green Valley were significantly similar to that of Njokerio showing the residence activity were the same. The *MC* mean value of 41.1% results also agreed with the findings by De-Medina-Salas (2013), Das and Bhattacharyya (2013), Yildiz *et al.* (2013), Chang *et al.* (2009) and Katiyar *et al.* (2013) who established that the mean *MC* ranged from 15.0 to 68.5%. There was no need of using the auxiliary fuel since the mean *MC* values did not exceed 50% as recommended by De Medina *et al.* (2013) considering 5% levels of significance. However, these results differed with the findings by Alhassan and Tanko (2012) who observed that solid wastes from Nigeria had mean moisture contents of 10.3%. The differences could be due to high levels of polythene papers, rubber/tyres, photocopying papers and plastics in waste reported in literature.

4.2.2 Volatile matters

The volatile matters (*VM*) is the vapour released when solid wastes is heated. As shown in Figure 4.2, the wastes from Egerton University had the highest *VM* of 46.6% since it contained higher levels of photocopying papers, polythene papers, litters, rubber and plastics. The Green Valley had 34.9% and Ng' ondu 27.5%, while Njokerio had the lowest *VM* of 23.9%. The solid wastes from Njokerio, Green Valley and Egerton University were significantly different since the error bars on volatile matters did not overlap implying that residents generated different types of garbage.

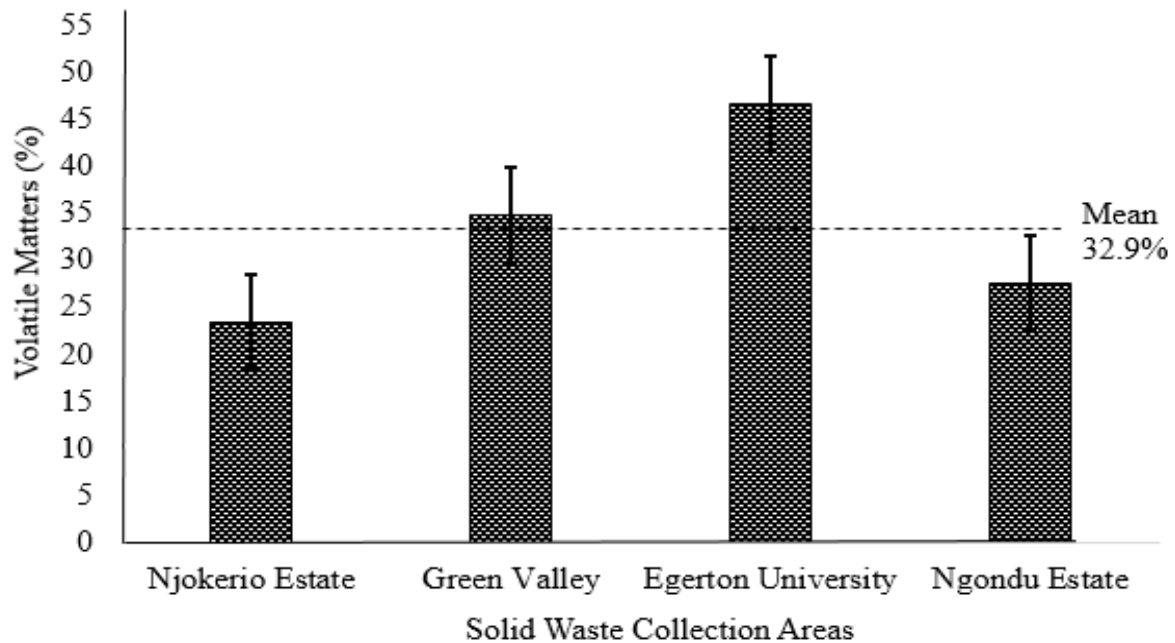

Figure 4.2: Volatile matter mean wastes characterization results from various areas.

Scrutiny on the statistical results in *Table A3.3 (ii) in the Appendix* reveals that *F-value* of 145.96 was greater than the critical value of 4.07 shown in *Table A3.2 in the Appendix* with the *LSD* of 3.68%. The results clearly indicated that volatile matters of wastes from concerned was significantly different at 5% confidence level. The waste from Njokerio were significantly similar to that of Ng’ondu since superscript ‘a’ was the same in that column. The volatile matters mean of 32.9% results falls within the findings by Omari *et al.* (2015), Katiyar *et al.* (2013) and Bernardo (2011) that mean *VM* of solid wastes ranged from 20 to 46.6% by weight. According to USCAR (2014), wastes with high *MC* and low volatile matters required more time to burn an equivalent volume, resulting to use of auxiliary fuels.

4.2.3 Ash content

The ash content (*AC*) is the non-combustible residues left after burning of solid wastes as specified by Ansah (2014) and Khamala and Alex (2013). The mean ash content of solid wastes from Egerton University and Njokerio ranged between 10.1 and 17.8%. The *F-value* of 19.54 *Table A3.3 (iii) in the Appendix* was greater than critical value of 4.07 at 5% confidence level with the *LSD* of 1.52%. The observations from Figure 4.3 showed that ash contents from Njokerio and Ng’ondu were significantly similar but differed with that of Egerton University. The waste from Green Valley were significantly similar with those of Ng’ondu. The *AC* mean value of 14.96% results compares well with Chang *et al.* (2008), Omari (2013) and Katiyar *et al.* (2013) who explicitized that ash content levels ranged between 4.4 and 22.9 %. The *AC*

mean of 10.06% results from Egerton University also agreed with findings by Zhang *et al.* (2010) that mean AC from China had mean values of up to 10.8%.

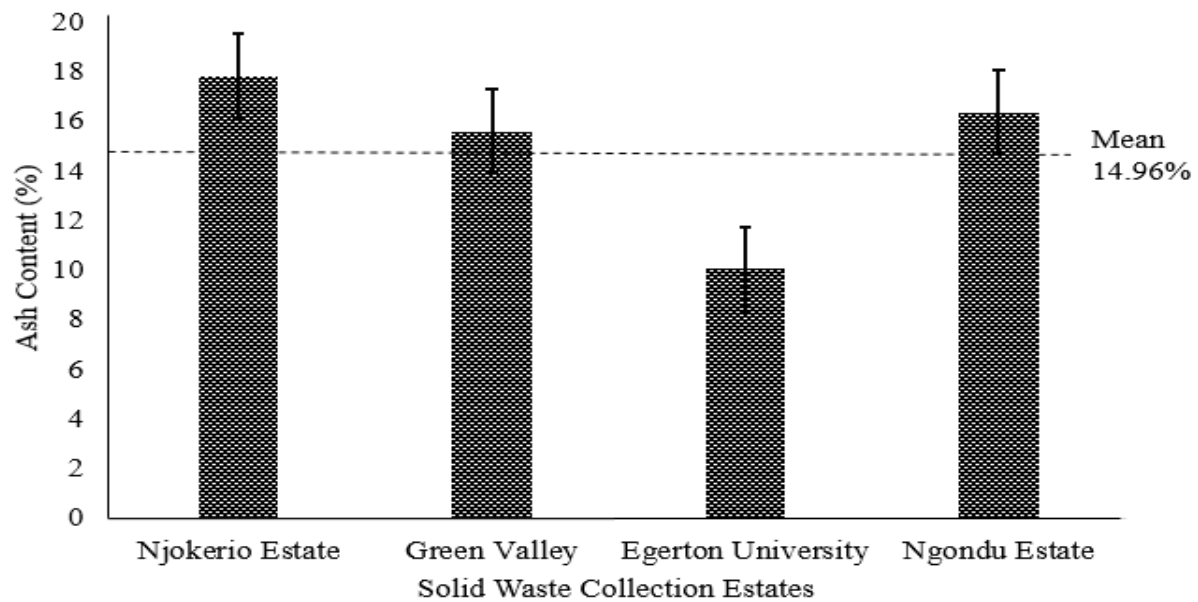

Figure 4.3: Ash content mean wastes characterization results from different areas.

Moreover, the research results of the ash content values were lower than 50% which are considered optimal as observed by De-Medina *at el.* (2013), for use of incineration techniques without auxiliary fuels as wastes final treatment to be applied.

4.2.4 Fixed carbon

The fixed carbon (FC) of waste is the percentage of carbon available for char in combustion processes as specified by Alhassan and Tanko (2012). The solid wastes characterization mean fixed carbon from various estates are presented in Figure 4.4.

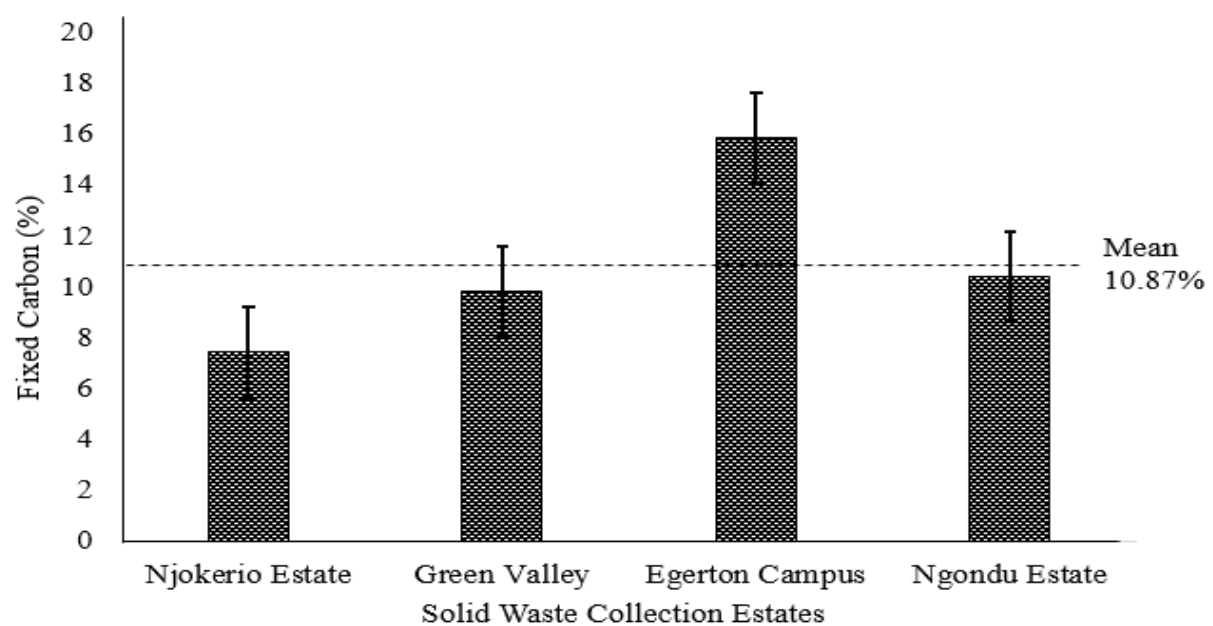

Figure 4.4: Mean fixed carbon of wastes characterization from different areas.

The mean fixed carbon ranged between 7.0 and 15.8% for Njokerio and Egerton University, respectively and *F-value* of 99.85 *Table A3.3 (iv) in the Appendix*, critical value of 4.07 and *LSD* of 0.967% at 0.95 confidence interval. The fixed carbon from Green Valley and Ng’ondeu areas were significantly similar but differed significantly with that of Egerton University and Njokerio areas. These results agreed with the findings by Omari (2013) and Oumarou *et al.* (2012) who expressed that values of fixed carbon from solid wastes ranged from 1.7 to 16.6%. The *FC* mean value of 10.79% differed with the findings by Katiyar *et al.* (2013) who noted that solid wastes in Bhopal, India had mean of up to 9.5%. This difference could have been due to low levels of photocopying papers, polythene papers, plastics and dry litters in the waste investigated.

4.2.5 Calorific value

The calorific values (CV) depends upon moisture contents, carbon and hydrogen content in solid wastes, representing the chemical energy in a given garbage component as recommended by Bujak (2010) and Ogwueleka (2009). The calorific values of solid waste from various areas in Njoro are presented in Figure 4.5.

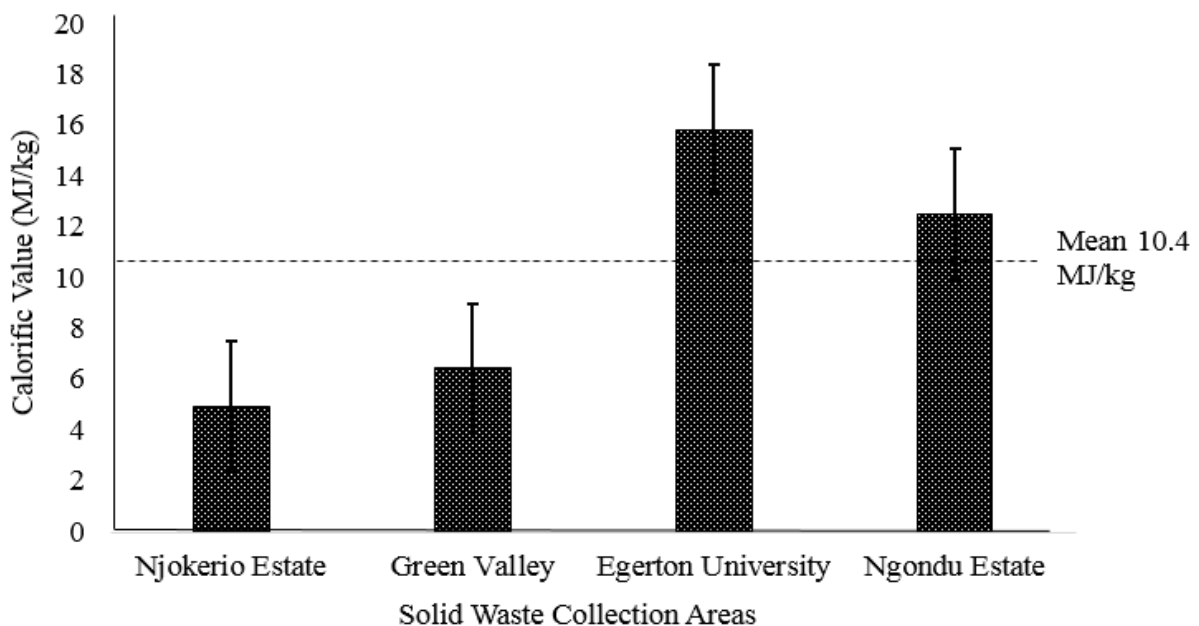

Figure 4.5: Calorific value mean wastes characterization from various areas.

As observed from Figure 4.5, solid wastes from Egerton University had highest calorific value of 15.9 MJ/kg while that from Njokerio had least of 5.0 MJ/kg. As shown in *Table A3.3 (vi) in Appendix*, the *F-value* of 189.4 was above the critical values of 4.07 with *LSD* of 1.32 at 5% confidence level. The calorific values of wastes from Njokerio and Green Valley were significantly similar but differed significantly from Egerton University and Ng’ondeu. The results agreed with the findings by Khamala and Alex (2013), Bhattacharyya (2013), Rimaityté

et al. (2010) and Das and Bhattacharyya (2013) who noted that mean calorific value of solid wastes ranged between 5 and 44 MJ/kg. The mean CV of 9.9 MJ/kg results exceeded what was recommended by Oumarou *et al.* (2012) that mean CV of 9.5 MJ/kg or less required the use of auxiliary fuels for energy recovery. This implied that additional of supplementary fuels for the solid wastes incineration in the study areas was unnecessary.

4.2.6 Density of solid wastes

The density is important in solid wastes management decisions which includes handling, collections, storages, transportations and the designs of disposal equipment. The density of wastes from the study areas ranged from 185.5 to 307.6 kg/m³. The waste density for Njokerio had the highest while Egerton University had lowest. The solid waste densities from Njokerio and Ng'ondeu were significantly similar but different with those from the Green Valley and Egerton University as shown in Figure 4.6.

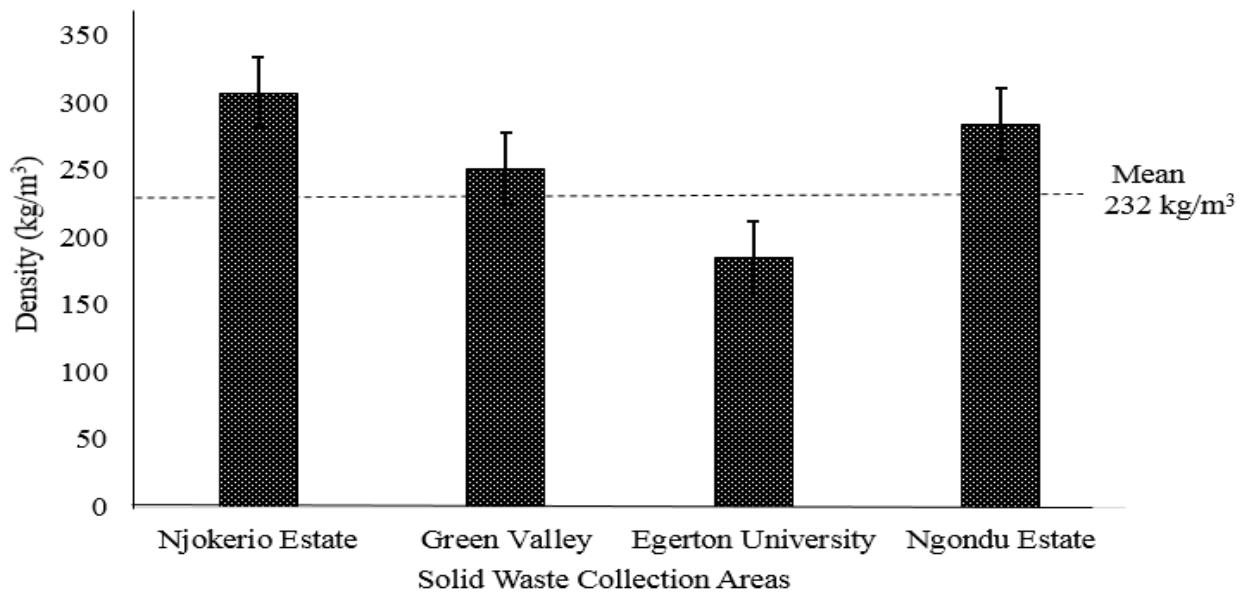

Figure 4.6: Density mean waste characterization from various areas.

The calculated *F-value* of 104.5 in Table A3.3 (*v*) in the Appendix was greater than critical value of 4.07, *LSD* of 23.4 at 5% confidence level and a mean of 257 kg/m³. The high values of waste density from these areas could be due to ashes residues, market garbage, leftover food from restaurants and waste water poured at the collection bins. Waste from Egerton University had the lowest density since it contained high levels of plastics, polythene papers, rubbers, tyres which do not absorb water from atmosphere. According to Yildiz *et al.* (2013), the density varied with wastes compactions, compositions and decomposition.

The wastes density mean of 257 kg/m³ results was in agreement with the findings by Suthapanich (2014), that mean wastes density in Thailand ranged from 176 to 350 kg/m³. The

results also agreed with findings by Bichi and Amatobi (2013) and Ogwueleka (2009) that mean wastes density ranged between 180 and 340 kg/m³. However, these results differed with the findings by Katiyar *et al.* (2013) and Fobil *et al.* (2005) that waste mean density ranged from 315 to 540 kg/m³. This difference could have been attributed to ash, food scrapes, glass and metals in the waste in the literature. Since solid wastes characterization from Njokerio and Ng' Ondu areas were significantly similar at 5% level of significance, implied that residents have similar economic activities and life styles.

4.3 Factors Influencing Performance of Solid Waste Incineration Processes

This section includes findings of solid wastes incineration at varying: moisture contents; incinerator loading rates; and operating temperature levels. The incineration processes was influenced by solid waste sizes/types, mixing, loadings rates, shape of combustion chambers, wall insulations, levels of turbulences and methods of air injections as established by Petridis and Dey (2018). The low operating temperature levels, low wastes heating values and reduced turbulence resulted into increased residence time and high emissions similar to what Ujam and Eboh (2012) and Astrup *et al.* (2011) experienced. The incineration performance was evaluated in terms of flue gas emission levels which were carbon dioxide (CO₂) carbon monoxide (CO), and hydrocarbon (HC) including smoke opacity and bottom ash residues assessments.

4.3.1 Effects of wastes incineration at varying moisture contents on emission levels

Since moisture content (MC) is a non-burnable components in wastes hence, must be kept to a minimum for its easy vaporization during combustion drying phases as specified by Niessen (2010) and Huang *et al.* (2006). The effects of waste incineration at varying moisture contents on emissions is presented in Table 4.2.

Table 4.2: Effects of waste incineration at varying moisture contents on emissions.

Moisture Content (%)	Carbon Monoxide (ppm)	Carbon Dioxide (%)	Hydrocarbon (ppm)
15	4.619	5.341	507.923
30	5.744	7.149	688.128
45	7.539	9.743	856.816
60	8.873	11.422	1024.734
75	10.945	13.834	1168.336
Mean	7.544	9.498	849.186
LSD	1.0213	1.281	102.308

The unpleasantly odour and liquid in association to garbage are due to putrescible organic components on leftover foods, vegetables, peeled materials and decaying fruits contaminates. These components are nuisance to the community and complicates the incineration processes similar to what Oumarou (2015) and Bradfield (2014) observed. The solid waste in the collection bins should be covered or stored inside sheds or other secure buildings to keep rain and moisture out. The *MC* of solid waste during incineration processes should be reduced in order to decrease the amount of smoke opacity produced and to increase combustion completeness. The mean values for carbon dioxide (CO₂), carbon monoxide (CO) and hydrocarbons (HC) flue gas emissions during wastes incineration at varying moisture content. The means *MC* for *CO*, *CO*₂ and *HC* emissions were different in same column meaning it was significantly different at $\alpha = 0.05$ and increased linearly in the *MC* as presented in Figure 4.7.

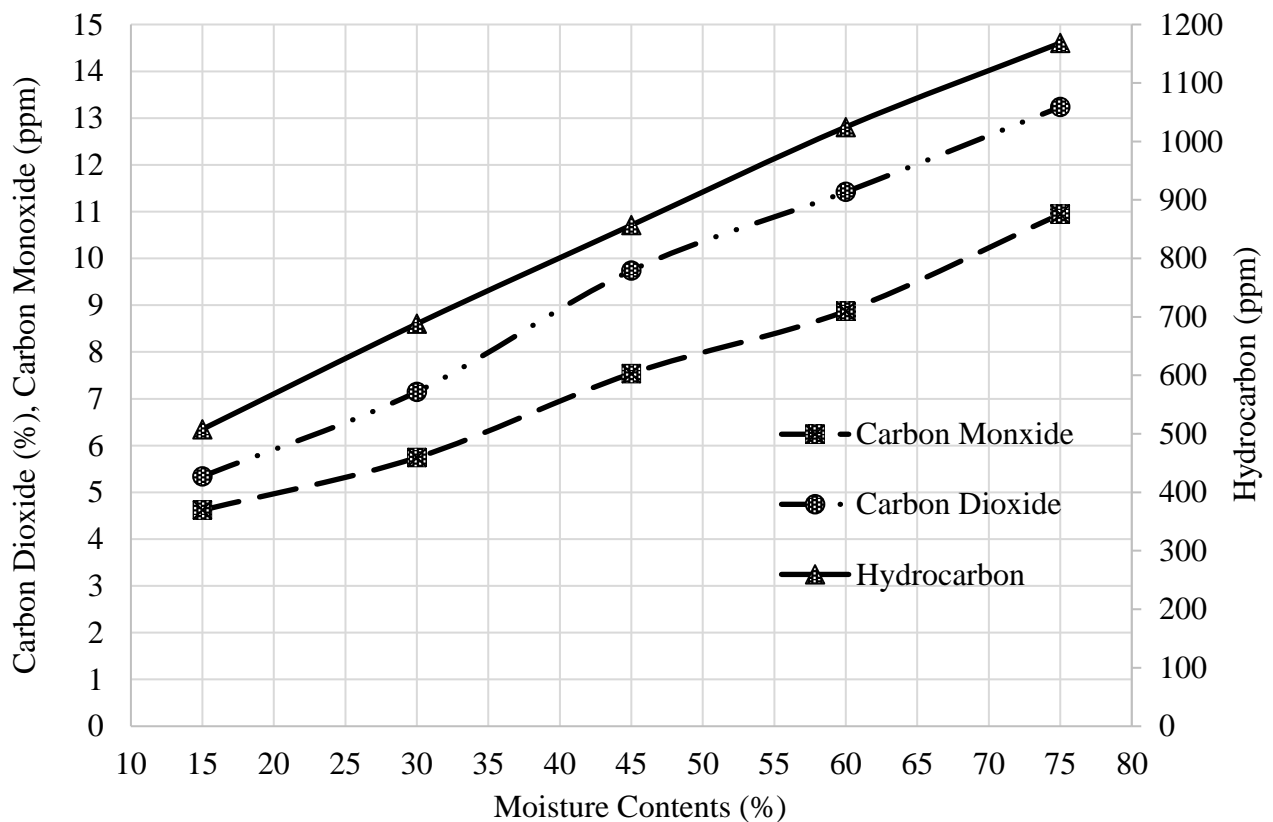

Figure 4.7: Effects of moisture contents on emission levels.

a) Carbon monoxide emissions at varying moisture contents

The carbon monoxide (CO) is highly toxic, flammable, colourless and odourless gases which is slightly lighter than air and slightly soluble in water. As observed on Figure 4.7, the *CO* emissions increased linearly with increase in moisture contents. The increase in moisture contents from 15% through 75% led to subsequent increase in the mean *CO* from 4.6 to 10.9

ppm. Scrutiny in *Table A3.1 in the Appendix* showed the standard deviation ranging from 0.14 to 0.73 ppm and mean of 7.5 ppm. The calculated *F-Value* for *CO* of 1.079 ppm in *Table A3.4(i) in the Appendix* was lower than the critical value of 2.48 ppm and the respective probability of 0.000101 was less than $\alpha = 0.05$ with *LSD* = 1.0213. This insinuated that additional moisture content into solid wastes significantly influenced the *CO* emissions in flue gas differently. These results agreed with the findings by Batterman (2004) and Salam (2013) who stated that *CO* emissions from waste incineration should not exceed mean 40 ppm. It also agreed with finding by Quina *et al.* (2011) and Neuwahl *et al.* (2019) that the daily means *CO* ranged between 5 ppm and 50 ppm for optimum combustion conditions.

The polyvinyl chloride, polystyrene, plastics and rubbers/tyres generated high *CO* emissions due to its high volatile matter contents. The *CO* in flue gases contains significant amount of energy that could completely be incinerated to produce heat energy and efforts must be made to minimize its formation as emphasized by Dong *et al.* (2016). The mean *CO* emissions increased with rise of *MC* in the combustion chamber due to vapour (water) gas reactions. According to Thompson and Anthony (2005) and Botter *et al.* (2002) the carbon monoxide could be bound by blood haemoglobin stronger than oxygen to form carboxyhaemoglobin (COHb) which inhibit supply of oxygen to body tissues. The exposure to *CO* and *HC* could affect the cardiovascular system, central nervous system, foetus and other organs that are oxygen deficient like heart and lungs.

b) Carbon dioxide emissions at varying moisture contents

The moisture contents in the waste components highly influenced the carbon dioxide (*CO*₂) discharged through incinerator's chimney/stack. The wastes incineration at varying *MC* from 15 through 75% caused mean *CO*₂ emissions to increase from 5.4 to 13.2%. The addition of *MC* into solid wastes, significantly influenced *CO*₂ emissions differently where *LSD* was 1.281 and mean of 9.5%. These results were within the findings by Chen *et al.* (2014) and Macknick (2011) who published that *CO*₂ concentrations from flue gas of incinerators ranged from 5 to 15%. According to Chen and Lin (2010), the higher *CO*₂ emissions the more efficient are operating processes hence, air/waste imbalances, misfires, poor design and mechanical problems may decrease the *CO*₂ formation. As a greenhouse gas, the *CO*₂ primarily enters the human body through inhalation of contaminated air. The *CO*₂ exposure can lead to difficulty in breathing, respiratory diseases, asthma, inhibition of the central nervous system, loss of consciousness and eventual cardiorespiratory failure, lung cancer and even death as described by Cogut (2016).

c) Hydrocarbon emissions at varying moisture contents

The formation and release of hydrocarbon (HC) is strongly dependent on the combustion conditions in the system. These includes combustion temperatures, resident time, turbulence, air to waste ratios, moisture contents and loading/charging materials as expressed by Dyke *et al.* (2003). Solid wastes incineration at varying moisture contents of 15, 30, 45, 60 and 75 % contributed to mean HC emissions of 508, 688, 857, 1024 and 1168 ppm, respectively with mean of 849 ppm. As expressed in *Table A3.4(iii) in the Appendix* the calculated *F-Value* of 2.15 ppm was less than the critical value of 2.48 ppm and *probability of 0.000117* lower than $\alpha = 0.05$ with *LSD* being 102.3 ppm. This indicated that waste incineration at varying *MC* significantly influenced mean HC emissions differently. These results were within the findings by Lee *et al.* (2002), Chen *et al.* (2014) and Saeed *et al.* (2009) that the hydrocarbons concentrations at the chimney ranged from 254 to 1970 ppm. The *MC* results of less than 45% had mean HC emissions lower than 700 ppm which were within the regulatory standards/limits recommended by Environmental Management and Co-ordination Act- Kenya (1999). The high *MC* reduces the combustion efficiency leading to high levels of HC emissions.

The solid wastes containing plastics, polymer, polythene papers and rubber discharged high HC emissions, large amount of particulate matters including heavy and dark smoke opacity due to incomplete combustion. The higher moisture contents would prolong the wastes drying process hence, weakening the combustion efficiency which leads to increased emission levels. When incineration very wet solid wastes, the ignition burner should be set to remain on until it is completely burned. The wet putrescible materials separation was necessary in order to increase waste heating values so as to reduce the flue gas emissions. The incineration performance is highly affect by the *solid* waste *MC* and heating values.

4.3.2 Influence of varying incinerator loading rates on flue gas emissions

The waste incinerator loading rates is also a measure of incineration performance. In this study, the overloading of incinerators resulted into increased flue gas emissions and incomplete wastes combustion in which the bottom ashes contained unburnt particles. The observations at the chimney exit of dark and dense smoke opacity was similar to what was expressed by Straka *et al.* (2018), Saeed *et al.* (2009) and Tangri (2003). The open wastes burning process is where the by-products and materials are burned at lower temperature levels and uncontrolledly manner with high flue gas emissions. Most of open wastes burning is unregulated and is nearly impossible to measure the emission levels as observed by Kumar *et al.* (2017) and Park *et al.* (2013). The poorly designed small-scale incinerators at Neveah Court and at Sajendu Hostel

which resulted into the non-performance of incineration system leading to open wastes burning are shown in Plates 4.1 and 4.2.

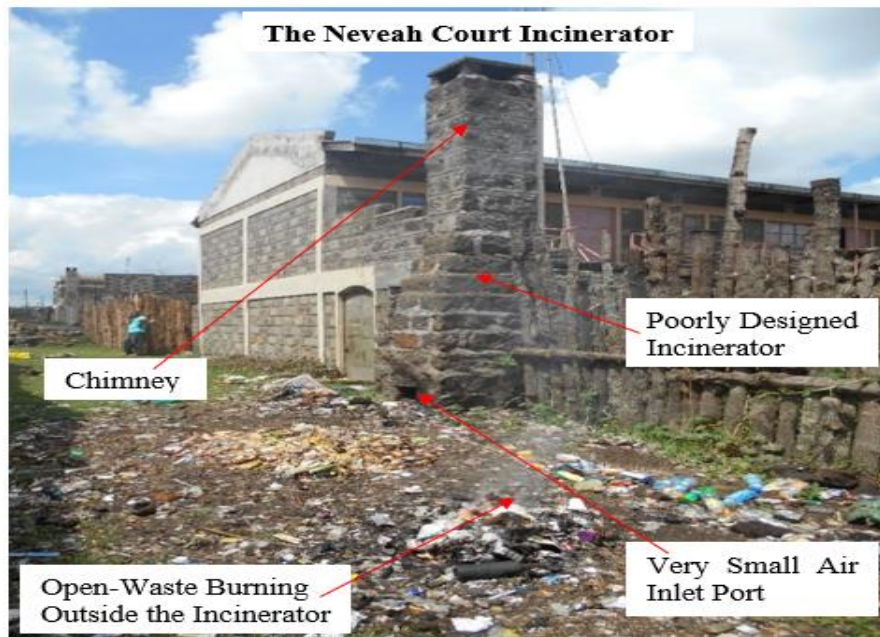

Plate 4.1: The poorly designed incinerator resulting to open wastes burning



Plate 4.2: Non-performing incinerator at Sajendu Hostel due to poor design.

Open wastes burning releases variety of toxic pollutants into the air which includes carbon dioxide, methane particulate matter, polycyclic aromatic hydrocarbons, dioxins and furans (Cogut, 2016). The concentration of oxygen gradually decreases as the oxidation reaction increases. The waste incineration processes at various loading rates mean values for CO , CO_2 and HC emissions are presented in Table 4.3.

Table 4.3: Influence of varying incinerator loading rates on flue gas emissions.

Loading Rate (kg/h)	Carbon Monoxide (ppm)	Carbon Dioxide (%)	Hydrocarbon (ppm)
15	5.022	5.428	252.426
30	7.474	8.583	594.348
45	9.053	11.352	837.119
60	10.534	12.963	993.235
75	11.784	13.889	1096.128
Mean	8.773	10.443	754.651
LSD	1.2312	1.4114	93.5138

The means were different in respective columns hence the increase in incinerator loading rates from 15 through 75 kg/h resulted into significant increase in CO_2 , CO and HC emissions towards maxima at around 75 kg/h. Solid wastes incineration at varying loading rates from 15 to 75 kg/h resulted into CO , CO_2 and HC mean emission values ranging from 5.0 to 11.8 ppm, 5.4 to 13.9% and 253 to 1096 ppm, respectively. This indicated that the addition of wastes into incinerators significantly influenced emission levels differently. The incinerator loading rate verses the carbon dioxide, carbon monoxide and the hydrocarbon is presented in Figure 4.8.

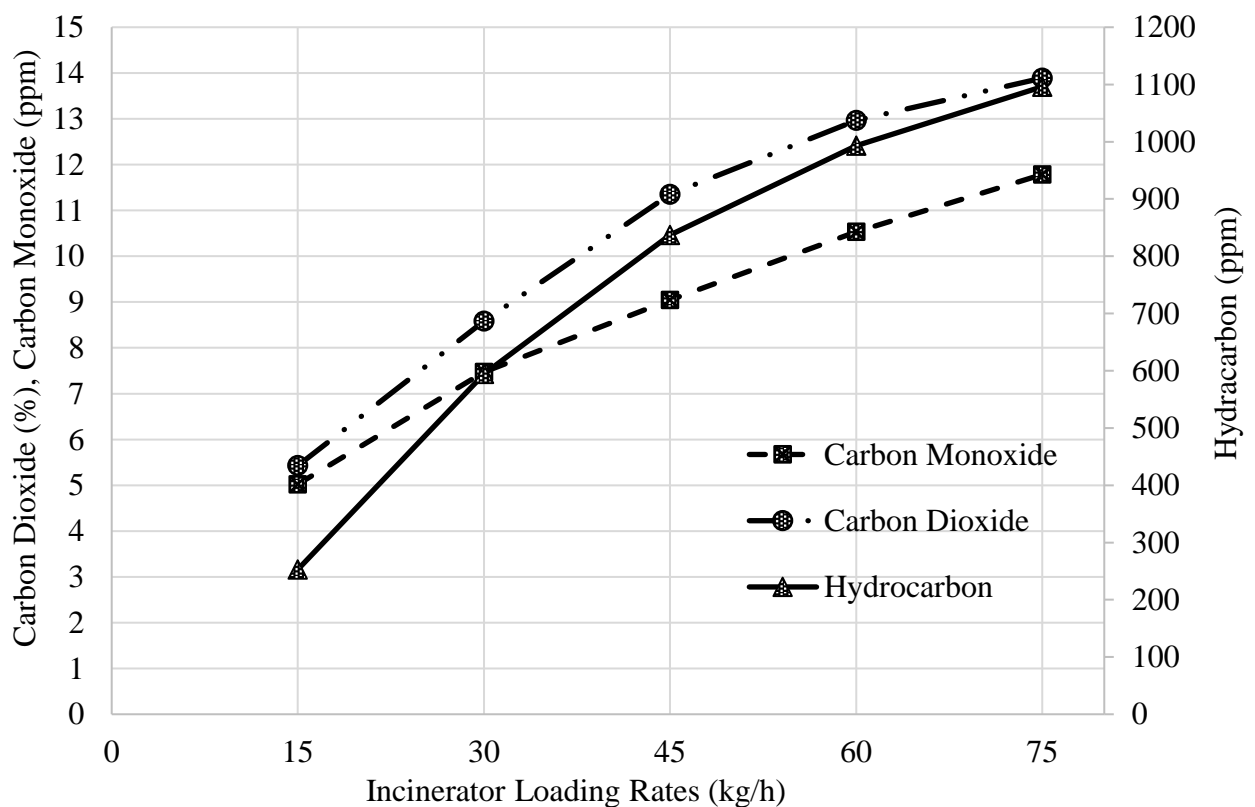

Figure 4.8: Influence of incinerator loading rates on gas emissions.

a) Carbon monoxide emissions at varying incinerator loading rates

The incinerator solid wastes loading rates highly influenced the *CO* discharged through the chimney. As observed from Table 4.3, mean *CO* had 8.77 ppm with *LSD* of 1.23 and *F-value* of 2.45 ppm in Table A3.4b (i) in the Appendix was lower than critical value of 2.48 ppm. The *CO* results were within the findings by Astrup *et al.* (2011) that *CO* from wastes incineration ranged between 4.5 and 16 ppm. However, these results differed with what was published by Park *et al.* (2013), that mean *CO* emission concentration amounted to 94.1 ppm for sewage sludge's large-scale incinerator. The differences could be attributed by the incinerator used in the literature was a large scale and of sewage sludge type, improperly functioning. According to Quina *et al.* (2011), the increase of *CO* and volatile organic compounds contents in flue gases was a strong indication of furnace inappropriate burning conditions which agrees with the findings of this study. These improper burning conditions could be adjusted by increasing fresh air inlet, reducing pressure below the grid as well as increasing flue gases recycling at the combustion chambers.

b) Carbon dioxide emissions at varying incinerator loading rates

The higher the *CO*₂ emissions the more efficient are incineration processes. In this study, the solid wastes combustion was characterized by vigorous turbulent burning using high volumes of air with a consequent high rate of garbage destruction. The *CO*₂ calculated *F-Value* of 3.45% in Table A3.4b (ii) in Appendix was higher than the critical value of 2.48% with *LSD* of 1.41% at 5% confidence level and a mean of 10.4%. This indicated that the increase in loading rates subsequently raised the *CO*₂ emission levels. The mean *CO*₂ results was within the findings by USCAR (2014) and Rogers and Brent (2006) that mean *CO*₂ emissions concentration on flue gases from chimney ranged between 5.4 and 14.7%. Besides, the results also were within what Basham *et al.* (2004) and Tchobanoglous and Kreith (2002) observed, that wastes incineration outputted mean *CO*₂ ranging from 1.6 and 16.5%.

c) Hydrocarbon emissions at varying incinerator loading rates

The presence of hydrocarbon (HC) emissions in flue gases is a strong indication of incomplete wastes combustion of organic compounds. The solid wastes burning at incinerators loading rates of 15, 30, 45, 60 and 75 kg/h produced mean *HC* emissions of 253, 594, 837, 993 and 1096 ppm, respectively. The calculated *F-Value* of 7.43 ppm in Table A3.4b (ii) in the Appendix was greater than critical value of 2.48 ppm with *LSD* of 98.2 and mean of 754.7 ppm. This signified that as the loading rates increased the *HC* emissions also expanded. The results were within the findings by Wu *et al.* (2014), Fang *et al.* (2004) and Yang and Chen (2004) that wastes incineration produced *HC* mean values ranging from 235 to 1650 ppm. Waste

incineration containing high levels of plastics, rubber, polythene papers released a large amount of *HC* emissions. According to Thompson and Anthony (2005), the exposure to high levels of *HC* could affect the cardiovascular system, central nervous system, foetus and other organs that are oxygen deficient the same way carbon monoxide do. The overloading of combustion chambers should be avoided since it leads to blocking of air flow and also reduces gas turbulences further.

4.3.3 Effects of incinerator operating temperature levels on flue gas emissions

The incinerator operating temperatures is critical to achieving high-efficiency combustion and destruction of organic materials. The chambers temperature generation is a function of facility unit design, combustion control, waste heating value, raw air supply and auxiliary fuel as Government of Nunavut (2012) and Van Caneghem *et al.* (2012) reported. The incinerators were inspected for signs of damage, corrosion or other physical defects before commencement of each incineration cycle. Any repairs services were completed before using the equipment to ensure the health and safety of operators, nearby community and the environment. The mean values of *CO*, *CO₂* and *HC* flue gas emissions are presented in Table 4.4.

Table 4.4: Mean flue gas emissions at various incinerator operating temperatures.

Operating Temp (°C)	Carbon Monoxide (ppm)	Carbon Dioxide (%)	Hydrocarbon (ppm)
180	13.743	14.911	1253.343
360	10.456	11.973	1049.351
540	8.157	9.613	817.447
720	6.239	7.495	567.025
900	5.033	6.133	316.043
Mean	8.727	10.025	800.642
LSD	1.1025	1.2824	98.1518

The incinerator should be designed, equipped, built and operated in such a way that the temperature levels of the gases is raised to 850°C with a residence time of at least two seconds and in the presence of at least 6% of oxygen (Tchobanoglous & Kreith, 2002). Since the means of *CO*, *CO₂* and *HC* in Table 4.4 were different in respective columns, it insinuated that gases emissions were inversely proportional to increase in incinerator operating temperatures. After solid waste burns down and all volatiles have been released, the primary chamber combustion air flow levels was increased to facilitate complete incineration of fixed carbon remaining in

ash residues. Hence, increasing the operating temperature from 180 to 900°C caused subsequent decrease in flue gas emissions as shown in Figure 4.9.

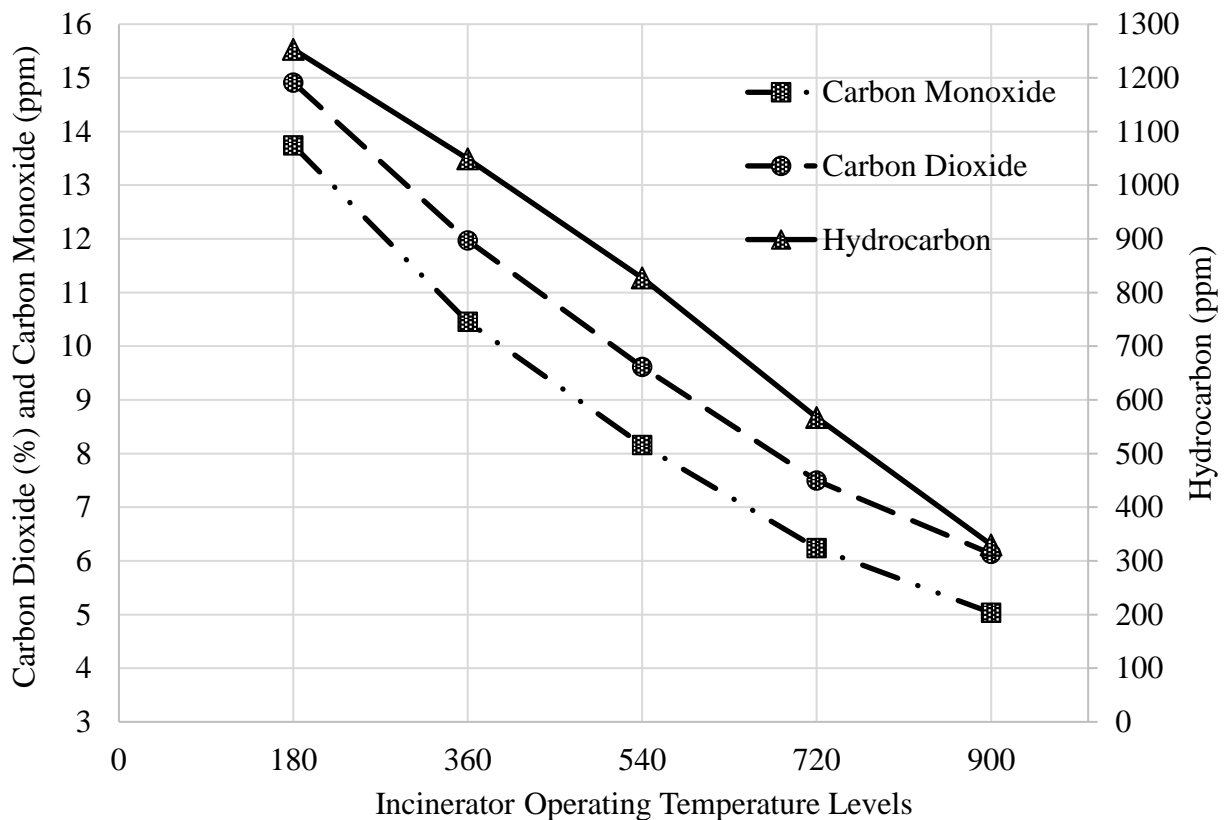

Figure 4.9: Effects of incinerator operating temperatures on flue gas emissions.

The turbulent mixing of burnable gases with sufficient oxygen was needed in promoting good contact between burning waste and incoming air. This would help in achieving high temperature levels which continued to decrease in primary combustion chamber indicating that solid waste was completely burned.

a) Carbon monoxide emissions at varying incinerator operating temperatures

The solid waste incineration at varying operating temperature levels increasing from 180 to 900°C was characterized by decrease in *CO* emissions from 13.7 and 5 ppm with mean of 8.7 ppm. The *CO* calculated *F-Value* of 4.47 ppm in *Table A3.4c (i) in the Appendix* was higher than the critical value of 2.48 ppm with *LSD* of 1.1 ppm. The results were in within the findings by Lombardi *et al.* (2013), Rogers and Brent (2006) and Rufo and Rufo J (2004) where emissions reduced to 5 ppm with increase in temperatures. The high mean values of *CO* at low operating temperature levels reflected inefficiency in the combustion process, incomplete destruction of organic compounds and loss of energy that should have been released in the incineration process. Moreover, the findings disagreed with Park *et al.* (2013) and Chen *et al.* (2014) expressed that *CO* concentrations from large scale wastes incineration ranged between

54 ppm and 618 ppm. The differences could have been due to insufficient combustion air, poor mixing, low operating temperature levels and incinerator used was a large scale type in the literature. The variables affecting *CO* emission concentration includes combustion chamber design, residence time, airflow turbulence, flame temperature and oxygen concentration.

b) Carbon dioxide emissions at varying incinerator operating temperatures

The increase in operating temperature levels from 180 through 900°C contributed to mean *CO*₂ emissions ranging between 14.9 and 6.1% with mean 10%. The *CO*₂ calculated *F-Value* of 5.22% in *Table A3.4c (ii) in the Appendix* was greater than critical value of 2.48% with *LSD* of 1.28%. The results agreed with the findings by Omari (2013), Environment Canada (2013), and USEIA (2011) who witnessed mean *CO*₂ emission levels from wastes incineration ranging between 14.9 to 4.2%. Also Chen *et al.* (2014) experienced similar trends where the emission levels reduced from 13 to 5% with increase in operating temperature levels. Similarly, these results differed with the ambient air quality tolerance limits of 4.0% in *Table 2.3 in Chapter Two* on residential/rural areas as well as what Musale and Padhya (2013) reported that *CO*₂ produced had a mean value of 18.4%. According to Macknick (2011) the *CO*₂ was higher at high temperatures due to released carboxyl, while *CO* and *HC* were produced instead of *CO*₂ at low temperatures due to cracking of volatile matters in wastes.

c) Hydrocarbon emissions at varying incinerator operating temperatures

The decreasing of mean *HC* emissions from 1253 to 316 ppm was contributed by subsequent increase in the operating temperature levels from 180 to 900°C. These results were within the findings by Lai *et al.* (2017) who published that mean *HC* ranged between 1,650 and 278 ppm. Besides, the mean *HC* emissions for operating temperature above 720°C were within the ambient air quality tolerance limits of 700 ppm specified by Environmental Management and Co-ordination Act- Kenya (1999). However, the *HC* results disagreed with the findings by Conesa *et al.* (2009) that mean *HC* emissions from large scale sludge waste incinerator at 850°C ranged between 117,740 and 4,376 ppm. The difference in emissions could have been due to inadequate waste-to-air mixing ratios, cold spots and as well as waste variety, air velocity and combustion mode, lack of maintenance and defective facility as reported by You (2008). The oxidization of combustible elements requires higher temperatures to ignite constituents, mixing of the materials with oxygen, turbulence and sufficient residence time for complete combustion as noted by Rimaitytė *et al.* (2010) and Doka (2003). When combustion chambers conditions are lowered chlorine and fluorine in wastes would be converted into acid hydrogen halides and hydrocarbon, part of which would react to form metal chlorides. Incinerators should be designed to burn complex mixtures of waste, hazardous and biomedical waste at a temperature

higher than 1000°C and holding time of at least two seconds to ensure complete combustion and to minimize dioxin and furan emissions (Government of Nunavut, 2012).

4.3.4 Assessment of smoke opacity at the chimney

The incinerators at Community Resource Center and Green Valley showed dark and dense smoke with excessive particulate matter emissions as shown in Plate 4.3 and 4.4, respectively.



Plate 4.3: Dark and dense smoke at Community Resource Centre incinerator

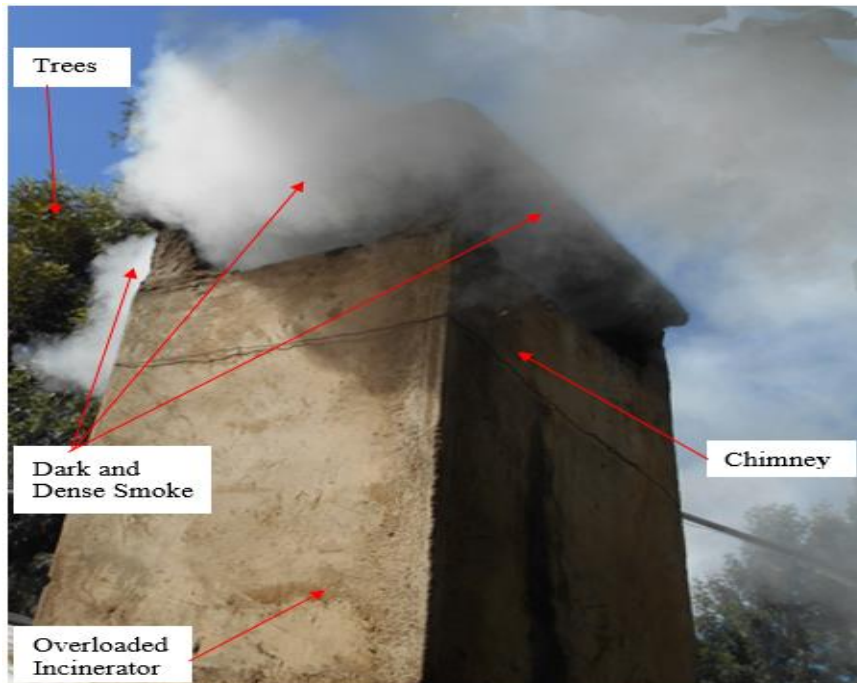

Plate 4.4: Dark and dense smoke from overloaded incinerator at Green Valley.

In this study, the smoke opacity obtained provided an indirect measurements of particulate matters concentration in chimneys which reflected the incineration performance and compares well with findings expressed by Park *et al.* (2013) and Rogers and Brent (2006). The fly ash consisted partially of burned dust-like grey organic matters ranging from 10 to 15% of the total ash residues as Reddy *et al.* (2018) and Lima and Bachmann (2002) established. The smoke evolution, including prolonged burning time and maximum intensity, varied with the type and quality of waste material burned. The smoke opacity was relatively high for waste containing rubber, polystyrene and plastics but lowest on rice hulls, photocopying papers and other dry agricultural residues.

As observed from Figures 4.7, 4.8 and 4.9, the high values of moisture contents and incinerator loading rates had direct relations to high flue gas emissions leading to dark and dense smoke but related indirectly to operating temperature levels. It was noted that solid wastes from Egerton University contained synthetic resins plus photocopying papers, polythene papers, dry rubbish and grass which ignited easily releasing less smoke. The high *MC*, fixed carbon and low calorific value in wastes causes maximum smoke opacity to be reached quickly leading to emissions of larger amounts of fine particulates within a short time similar to what Wang *et al.* (2015) and Ujam and Eboh (2012) reported. The particulate matters (*PM*) in flue gas was produced due to incomplete wastes combustion leading into respiratory irritations in both animals and human beings as emphasized by Park *et al.* (2013) and Thompson and Anthony (2005).

4.3.5 Assessment of bottom ash residues

The formation of bottom ash residues may be affected by various factors including furnace type, capacity, loading rate, residence time, flue gas velocity and combustion temperature levels as well as waste compositions. Moreover, the volatilization of waste materials increased with increase in furnace temperature which directly affected the concentration of elements in the bottom ash residues. As observed in Figure 4.10, the physical and chemical properties of incinerated bottom ash varied with types and sources of wastes, moisture contents, incinerator loading rates and operating temperatures. The results indicated that, wastes incineration at high loading rates of 75 kg/h and moisture contents of 60% and low operating temperature level of 180°C resulted in bottom ash containing slag and partially unburned organic matter. It also led to bottom ash containing large pieces of unburned materials (other than incombustible such as glass, cans and pieces of metal). These ash residues were generally black, coarse and sandy in appearance indicating poor incineration performance. The black residues indicated higher percentage of carbon remains in bottom ash. The results agreed with findings by Bernardo

(2011) and Guendehou *et al.* (2006) that combustion was incomplete for dark gray and black colour which was attributed to unburned contents.

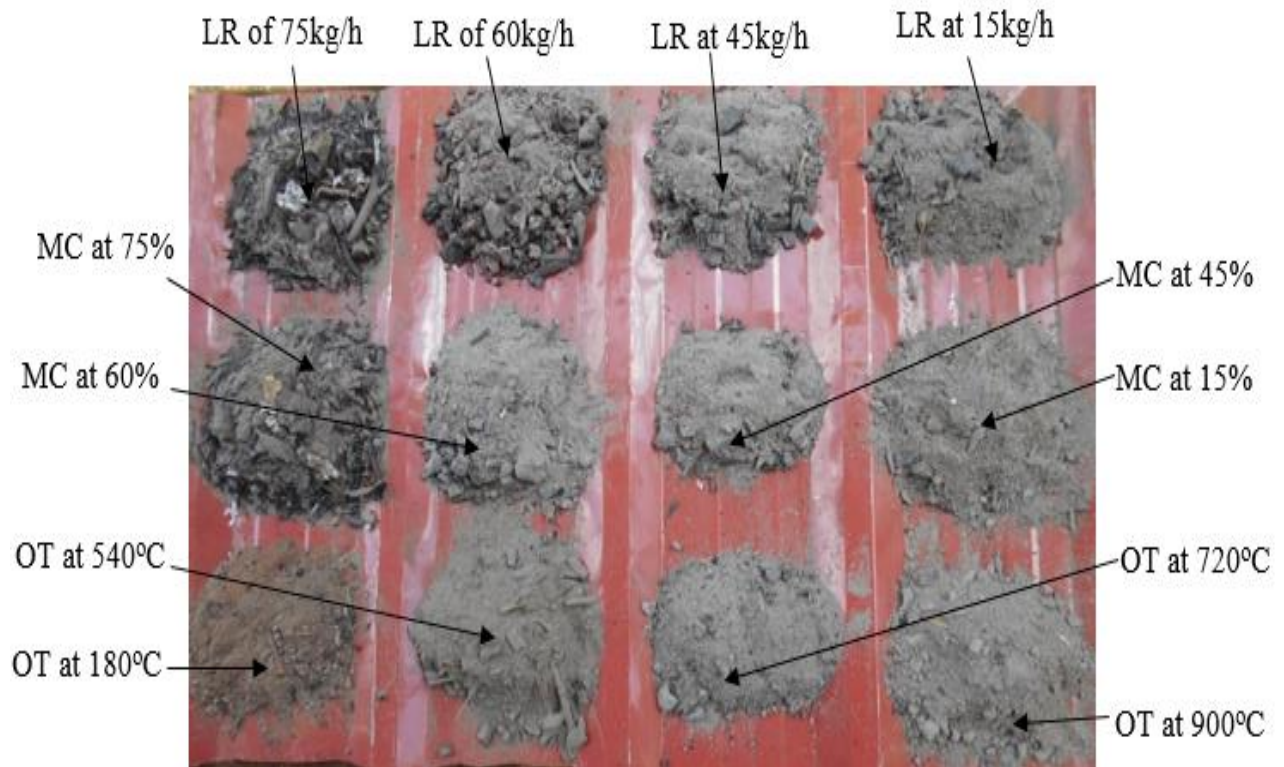

Key: MC- Moisture Content; LR- Loading Rate; OT- Operating Temperature

Figure 4.10: Bottom ash residues from different experiments.

The wastes incineration at lowest loading rate of 15 kg/h, least MC of 15% and highest operating temperature level of 900°C produced finest and grayish bottom ash residues, indicating a good incineration performance. As an indicator of ash quality, white and grayish ashes revealed low percentage of carbon remnant in bottom ashes insinuating wastes complete combustion comparing closely with findings by Alhassan and Tanko (2012) and Earle (2003). Some of good performing small-scale incinerators with high quality bottom ash indicated by white and grayish ash residues are presented in *Plate A1.2 and A1.3 in the Appendix*. According to Chang *et al.* (2009), the particulate matter of PM_{10} concentrations may cause severity and incidence of respiratory diseases such as aggravated asthma, coughing and painful breathing, chronic bronchitis, and lung malfunction. Therefore, the formation of PM_{10} should highly be minimized by the use of effective air pollution control devices.

4.4 Air Flow Patterns and Velocity Profiles Simulation for Small-Scale Incinerators

This research covered incinerators at Egerton University, Community Resource Centre and Janda Plaza including domestic one from the same neighbourhood at Green Valley. The air-

flow measurements using air-flow meter for the Stalla residential incinerator at Ng' Ondu areas is presented in *Plate A1.3 in the Appendix*. According to Ryu *et al.* (2002), the computational fluid dynamics play key roles in validation and optimization of the incinerators combustion designs and operations through production of valuable information on air/gas flowing fields. The combustion flow patterns, air/gas mixing and velocity and their clear views of complexities across the small-scale incinerators have been discussed.

4.4.1 The Egerton University dispensary incinerator air-flow and velocity simulations

The incinerator at Egerton University dispensary air flow patterns and velocity profiles were simulated as shown in Figure 4.11. The incinerator air inlet port and combustion chamber sizes were enough to accommodate air flowing, flue gases and waste streams with no obstructions at the entrance. The contour plots showed that flue gas flowing velocities profiles reached maximum value of 5.15 m/s at chimney exit and registered velocity of 1.92 m/s at air-entry port. The flue gas entry into the chimney from combustion chamber had a velocity of 2.81 m/s showing smooth flow.

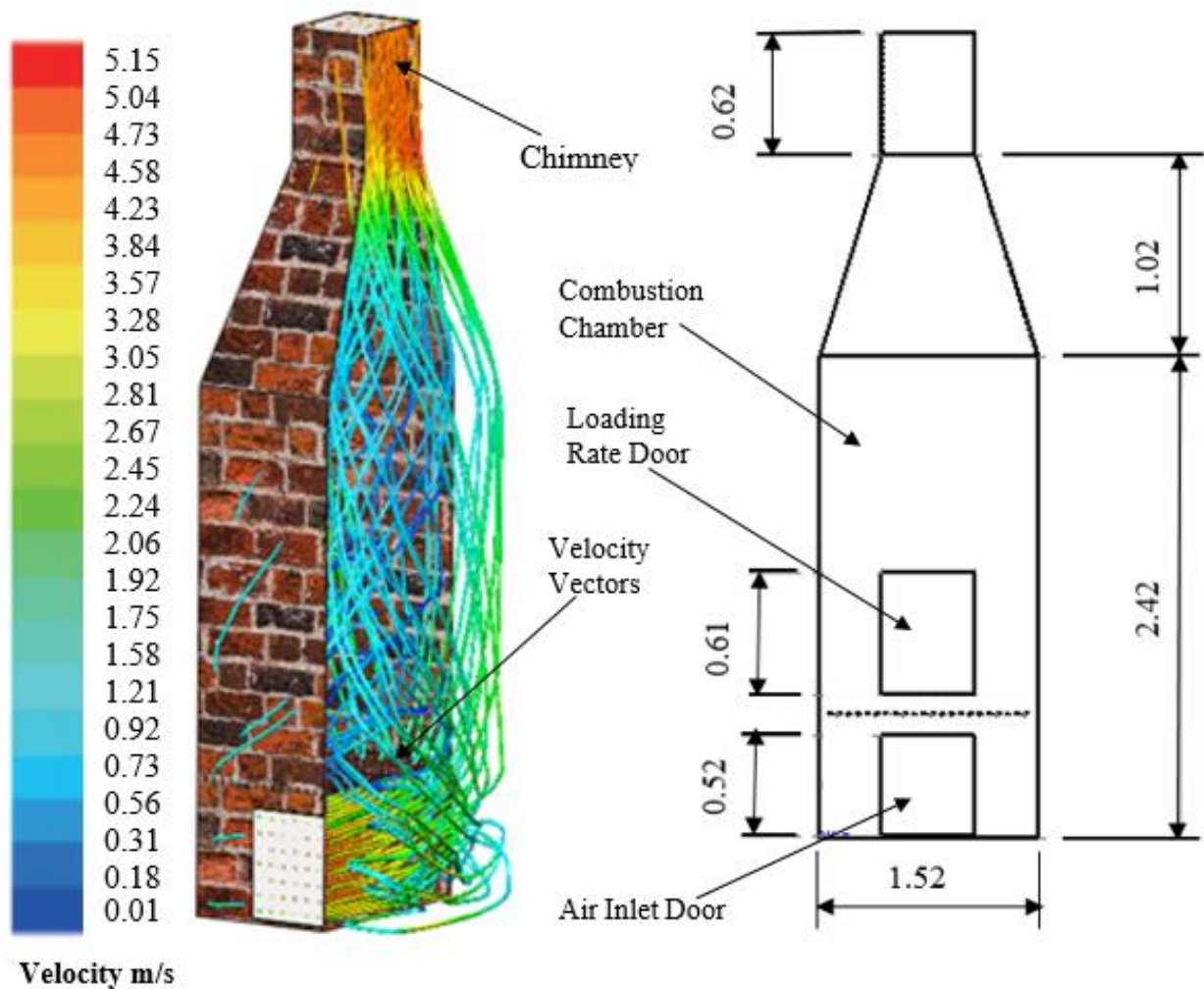

Figure 4.11: Airflow patterns and velocity profiles for dispensary incinerator.

The airflow particles in front and back walls were overlapping and induced flows towards grates, increasing its velocity profiles towards the chimney. The flow velocity distribution homogenized along flue gas path-way up to chimney exit without obstructions showing flow improvement and increased incineration efficiency. The incinerator had an even distribution of gases flow velocities especially in regions close to furnace walls indicating sufficient mixing conditions across all sections of combustion chamber, showing good incineration performance. The air-flow velocity of maximum 5.14 m/s results within the findings by Sachdev *et al.* (2012) in a vertical symmetry plane furnace which had a maximum velocity of 5.16 m/s. The results differed with findings by Brunner *et al.* (2009) that maximum flue gas velocity obtained in furnace was 17 m/s. The difference could be the literature incinerator was a large-scale type with blowers and had high loading rate and too long chimney. The Egerton University dispensary incinerator exhibited the finest and grayish white bottom ash residues an indication of wastes complete combustion which is presented in *Plate A1.3 in the Appendix*.

4.4.2 The Green Valley residential incinerator airflows and velocities simulation

The flue gases flow patterns and velocity profiles simulation for the incinerator at Green Valley residential home are presented in Figure 4.12. The maximum mean gas flow velocities at chimney exit was 4.34 m/s in a cloudy day. The air flow velocity at the air inlet port was 1.68 m/s and the gas flow velocity into entry of chimney from the furnace was 2.48 m/s.

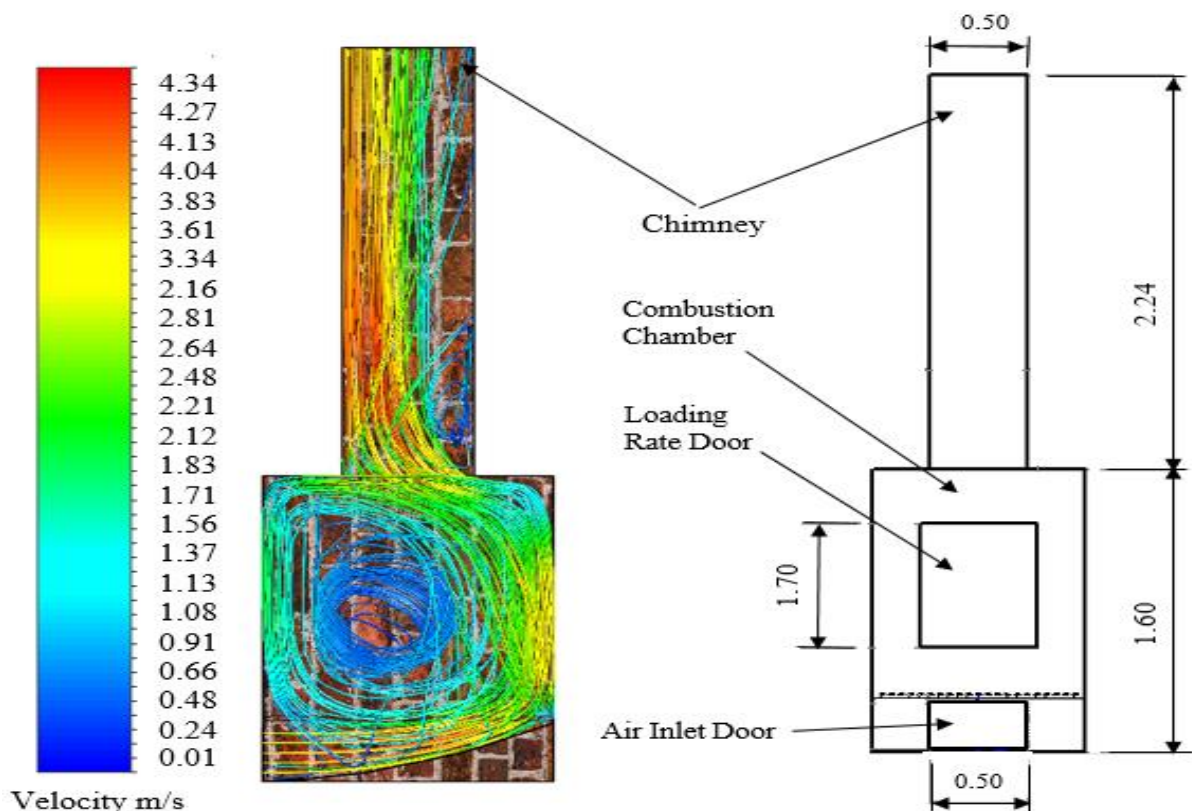

Figure 4.12: Incinerator airflow patterns and velocity profiles simulations.

The incinerator had a domed shape at air entry port and stack entry which reduced sudden contraction hence improving venture and gas flow velocities similar to what N’wuitcha *et al.* (2014), Ayaa *et al.* (2014) and Genick (2007) employed in their research. The results of 4.34 m/s were within the findings by Yang *et al.* (2004) that maximum flue gas velocities obtained in a hazardous waste incinerator yield to 4.3 m/s. The velocity profiles distributions were homogeneous along the flue gas flow pass way leading to good incineration performance. The finest and grayish white bottom ash signifying complete wastes combustion from the incinerator is presented in *Plate A1.2 in the Appendix*.

4.4.3 The Community Resource Centre incinerator airflows and velocities simulation

The Community Resource Centre (CRC) incinerator had a very narrow air inlet port and no domed shape at entry to combustion chamber and at stack entry and had very long chimney. The air flow patterns and velocity profiles simulations for *CRC* incinerator are presented in Figure 4.13.

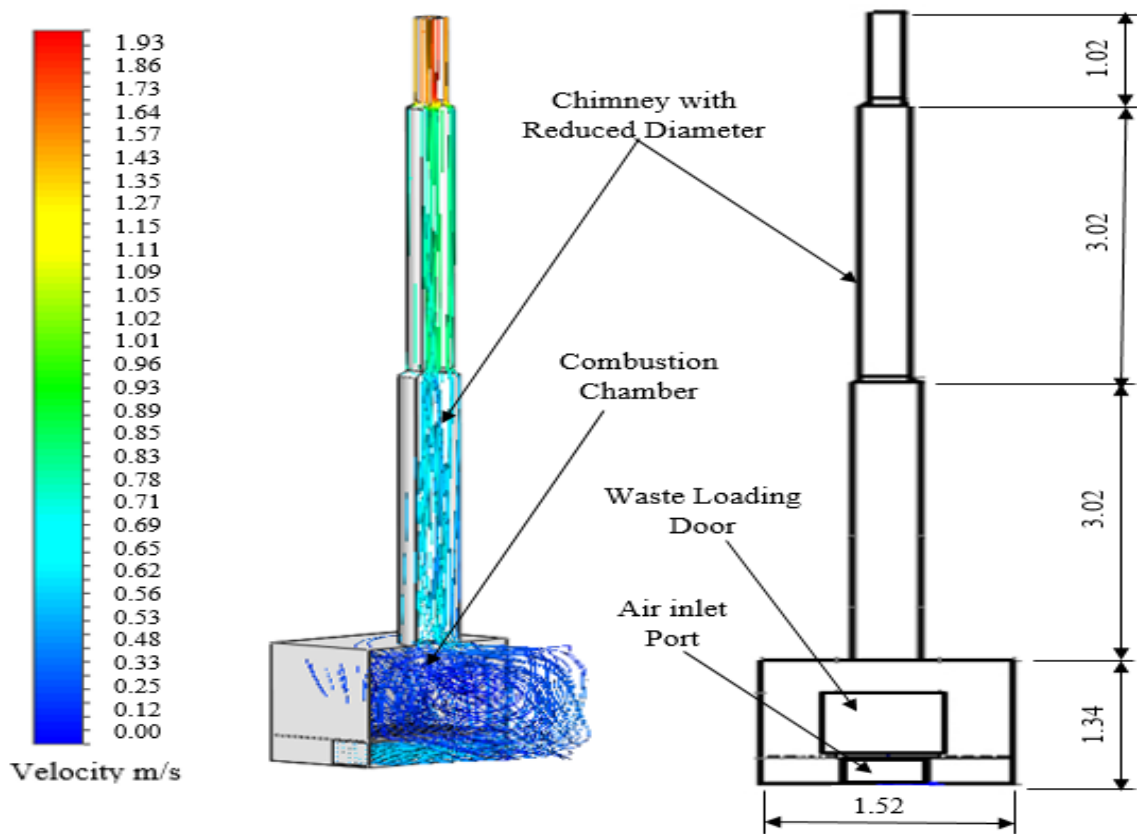

Figure 4.13: Air flow patterns and velocity profiles incinerator simulations.

The simulated *CRC* incinerator flue gas flowing velocity profiles at the chimney exit and inlet port exhibited maximum values of 1.93 m/s and 0.33 m/s, respectively. The *CRC* incinerator low air flow velocity values was due to poor mixing of unburned gases and heat

transfer to the surroundings, relatively small heating surface of the post combustion chamber and very long and narrow chimney. Also, there were high turbulences and eddies at the chimney entry from combustion chamber which contributed to flue gases flowing restrictions. These low flue gas velocities at combustion chamber created vacuum, forcing air at the chimney exit to flow backward leading to poor incineration performance. This results of backward flow compares well with findings expressed by Gaska and Generowicz (2017) and Hussain *et al.* (2006). However, these results differed with findings by Mashayak (2009) and Brosch *et al.* (2014) who published that the maximum mean velocity of 9.32 and 30.0 m/s respectively, for flue gases through an incinerator.

4.4.4 The Janda plaza incinerator airflows and velocities simulation

The air-flow patterns and velocity profiles simulation for the incinerator at Janda Plaza opposite the Njoro canning factory are presented in Figure 4.14. The incinerator had neither domed shape at air entry port nor at the chimney entry to fasten the deflection of gases flowing upward. This signified the air flow restrictions in combustion chamber and chimney tunnel.

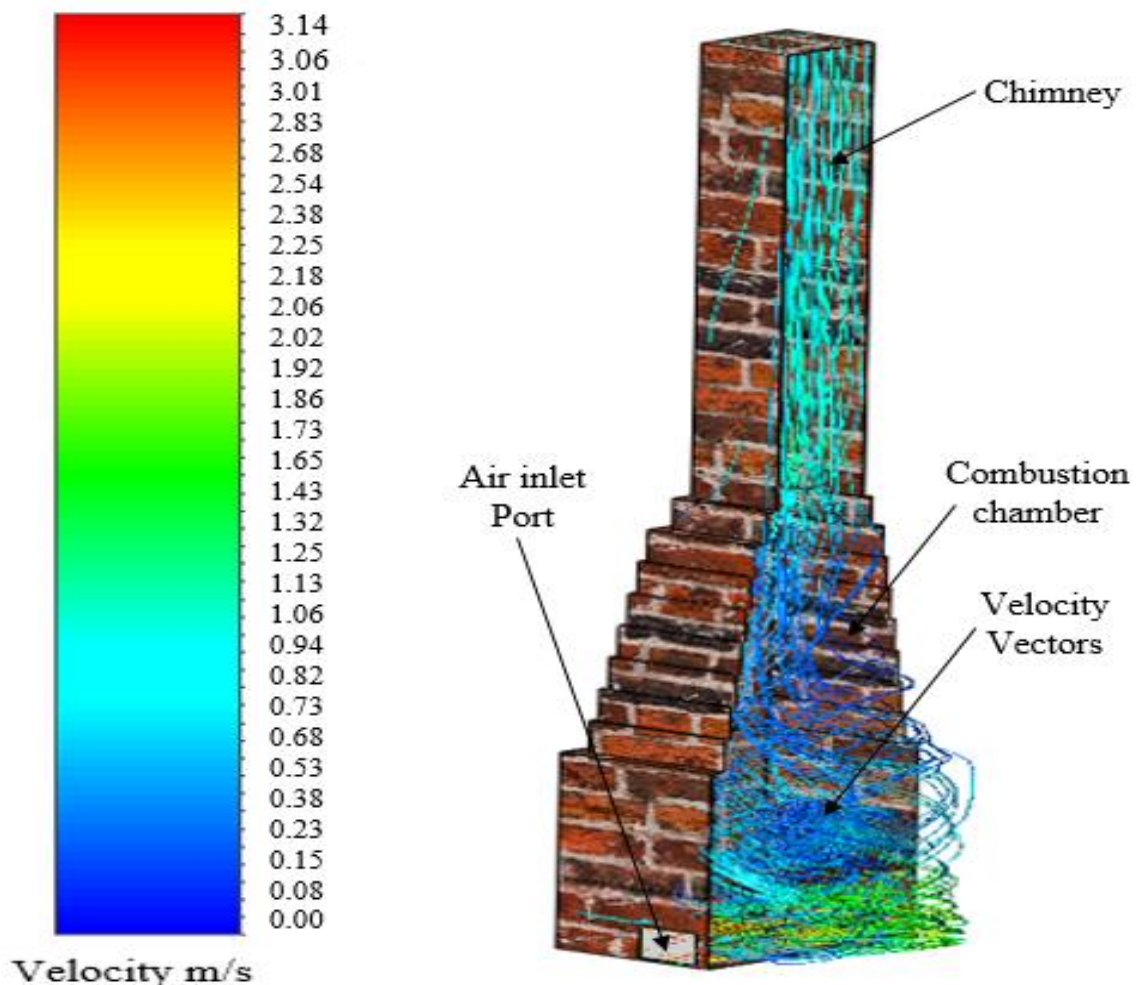

Figure 4.14: Air flow patterns and velocity profiles for the Janda Plaza incinerator.

The maximum gases flow velocity was 3.14 m/s at air entry port and at chimney exit had 0.94 m/s while at stack entry from combustion chamber produced 0.38 m/s. These high restrictions of air flow lead into backward flow of gases from stack exit resulting into poor incineration performance. The results differed with findings by Saripalli *et al.* (2005) who illustrated that flue gas velocities from the incinerator had mean of 9.47 m/s. The profiles led into incinerator combustion processes insight, where O_2 concentrations decreased with increase of CO_2 composition while CO and HC behavior was associated with imperfect combustion under constantly supplied air.

4.4.5 Incinerator design models and simulations

The simulations of square, rectangular, circular and triangular based shape incinerator models, initial conditions and assumptions were applied for both at inlets and outlets of the chimneys while walls were subjected to constant temperature. The models included Non-Isothermal flow predefined Multiphysics couples employing simulation systems whose densities varied with temperatures as specified by Pushpendra and Srivastava (2017). The formulation of continuity and momentum are defined by Equations 4.1 and 4.2, respectively.

$$\nabla \cdot (\rho u) = 0 \quad (4.1)$$

$$\rho(u \cdot \nabla)u = \nabla \left[-pI + (\mu + \mu_T)(\nabla u + (\nabla u)^T) - \frac{2}{3}(\mu + \mu_T)(\nabla \cdot u)I - \frac{2}{3}\rho kI \right] + F \quad (4.2)$$

where ρ is density (kg/m^3), u is velocity (m/s), p is pressure (Pa), μ is dynamic viscosity (Pas), F is body force vector (N/m^2), I is unit tensor, k is thermal conductivity, T is temperature (K), μ_T is the turbulent eddy viscosity which emulates the effect of unresolved velocity fluctuations and ∇ is del operator for outer product tensor of the vector field with respect to space and has neither magnitude nor direction. The standard k- ε model μ_T is given by Equation 4.3.

$$\mu_T = \rho C_\mu \frac{k^2}{\varepsilon} \quad (4.3)$$

where C_μ is a model constant, and ε is the dissipation rate of turbulence energy. The production term, P_k is given by Equation 4.4.

$$P_k = \mu_T \left[\nabla u \cdot (\nabla u + (\nabla u)^T) - \frac{2}{3}(\nabla \cdot u)^2 \right] - \frac{2}{3}\rho k \nabla \cdot u \quad (4.4)$$

The transport equation for k is given by Equation 4.5.

$$\rho(\nabla \cdot u)k = \nabla \cdot \left[\left(\mu + \frac{\mu_T}{\sigma_k} \right) \nabla k \right] + P_k - \rho \varepsilon \quad (4.5)$$

The transport equation for ε is given by Equation 4.6.

$$\rho(\nabla \cdot u)\varepsilon = \nabla \cdot \left[\left(\mu + \frac{\mu_T}{\sigma_\varepsilon} \right) \nabla \varepsilon \right] + C_{\varepsilon 1} \frac{\varepsilon}{k} P_k - C_{\varepsilon 2} \rho \frac{\varepsilon^2}{k} \quad (4.6)$$

where $C_\mu = 0.09$; $C_{\varepsilon 1} = 1.44$; $C_{\varepsilon 2} = 1.92$; $\sigma_k = 1.0$ and $\sigma_\varepsilon = 1.3$.

The gas flow velocities at the entry and chimney exit of the square based shape incinerator model were 2.26 and 5.19 m/s, respectively as shown in *Figure A1.3 in the Appendix*. The flue gas particle entered the chimney from combustion chamber at a velocity of 3.13 m/s and since the incinerator had no sudden contraction, there was smooth turbulence without creation of eddies. The incinerator displayed a good incineration performance. The gas flow patterns and velocity profiles simulated for this incinerator differed with the findings by N'wuitcha *et al.* (2014) which had a maximum gas flow velocity of 8.95 m/s in an isotherms distribution.

The simulation model for rectangular based shaped incinerator had gas particles flow velocity at the entrance to chimney of 2.02 m/s as shown in *Figure A1.4 in the Appendix*. The simulation of air flow patterns and velocity profiles for rectangular based incinerator, the gas particles attained a maximum velocity of 4.32 m/s at chimney exit and at air-inlet port had 1.76 m/s. The particle resistance to flow and subsequent large pressure drop dominated flow field distribution and its results were within findings by Lombardi *et al.* (2013) and HCWM (2009).

On the other hand, simulations of gas flow patterns and velocity profiles for circular-based incinerator exhibited maximum flue gas flow velocity of 6.43 m/s at chimney exit and 1.84 m/s at air inlet port as shown in *Figure A1.5 in the Appendix*. The flue gas particles velocity at entry to chimney from combustion chamber was 2.91 m/s which resulted into smooth turbulences and no eddies. The air flow passed under the grate with a swirl flowing directly to combustion chamber increasing the rate of wastes incineration. The burning swirling air reacted with unburned wastes and flue gas particulate matters for complete combustion processes as noted by Saripalli *et al.* (2005). The circular based shaped incinerator yielded good incineration performance except that producing true circular shapes from natural stones during construction is a challenge. The incinerator was the best in terms of performance.

The air flow patterns and gas velocity profiles of particles in the triangular based incinerator attained values of 1.37 m/s at the air entry port and 4.26 m/s at chimney exit. The gas flow velocity at air entry port was very low causing backward flow of smoke from the chimney exit as shown in *Figure A1.6 in the Appendix*. The results were within findings by Castellani *et al.* (2014) and Sun *et al.* (2015) that flue gas velocity of the particles a maximum of 4.25 m/s in a waste incinerator. In the combustion chamber, flue gas flow particles depended upon the waste type, its heating value and specific grate concept. The turbulences and eddies were high at chimney entry from combustion chamber resulting to high restriction of gases flow which agreed with findings published by Musa *et al.* (2019). This type of incinerator model performed poorly as compared to other models, but could be of great use where space is limited.

The airflow entry and exit velocities at the chimneys for square and rectangular based shaped incinerator models were above 2.0 and 2.9 m/s, respectively whereas that for triangular and circular-based shaped model were 1.5 and 4.51 m/s, respectively. Interestingly, both entry and exit velocities of gases flowing at the chimney for circular-based incinerator model were above 3.0 m/s resulting into great incineration performance improvements. The circular based incinerator type was more preferred than the other three models. The air flow velocities at entry and chimney exit for triangular based shaped model were extremely low at the entry but highest at the exit contrary to requirements indicating poor performance.

4.5 Compliance, Enforcement and Performance

The good solid waste management policies, prohibitions of practices, maintenance and monitoring procedures are effective in reducing the environmental pollutions. The efficient use of raw materials would reduce the waste generation, handling, storage, treatment and disposal while garbage segregation enables reuse for a different purpose as specified by Government of Nunavut (2012). The timely evaluations are done by trends monitoring and actual results comparison against the pre-determinable expectations as reported by Lorentsen and Burgeat (2004).

4.5.1 Incineration compliance

The incinerators construction requires dimensional drawings, adequate plans, tolerances, material lists and the quality controls. Permitting programs includes design review ensuring acceptable equipment is constructed and utilized; safe operation; maintenance; training of the operators; inventory and record keeping of facilities and track utilization as noted by Government of India (2009). Incinerator location can affect the plumes dispersion from chimneys, ambient concentrations, depositions and exposures to workers and community. Besides, smoke opacity at the stack should not exceed 20%, hydrocarbon 700 ppm, carbon monoxide 10 ppm and carbon dioxide 10% for industrial areas as specified by Environmental Management and Co-ordination Act- Kenya (1999) in *Table 2.3 in Chapter Two*. The incinerators preheating was necessary before any wastes loading to remove any moisture vapour in furnace chambers.

The compliance of study area incinerators was achieved by loading loosely dry cartons, photocopying papers, paperboard packing and untreated wood at the bottom during start-up. The dry and loose material ignited quickly and burn more evenly than wet, tightly packed loadings. The very wet waste materials was added only after the fire was actively burning. This practice greatly lowered emission levels, maintained an average temperature of 850°C and

improved the incineration performances. Insufficient combustion air at char burndown stage would result into ash residues containing excessive amounts of carbon. Thus, moderate levels of excess air was introduced at this stage by use of blowers to achieve final destruction of carbonaceous material remaining after burning of hydrocarbon.

The normal incinerators wastes loading and complete mixing of organic vapours and gases with adequate oxygen at high turbulence in secondary combustion zone assured completion of oxidation reaction processes. During this process some of carbon monoxide and hydrocarbon were converted into carbon dioxide and water vapor (steam) hence improving the combustion efficiency. Improper design of facilities intended to provide proper turbulence in waste and gases would retard and impede the drying, volatilization, and oxidation processes critical to high-efficiency destruction of garbage materials. This would result into low throughput, a high percent of unburned material in ash residues and serious emissions problems. Improper operation of a well-designed furnace by excessive wastes loading or improper balance of draft system would produce the same effects. Incinerators must be designed to use air pollution control devices, combustion process monitoring and process controls in order to meet the emission standards. The smoke opacity should not exceed 20% viewed from 50 m as the Kenya Law Reports (2012) emphasized.

4.5.2 Incineration enforcement

The installations, certifications, designing, operations and monitoring of emissions systems should comply with environmental standards/limits. The in-stack monitoring provided with additional information on furnace process and quantity of emissions released into environment which were equipped with visible and audible alarms for warning of any poor incinerator operations. The combustion processes monitoring sensors included *CO*, *CO₂*, *O₂*, and *HC* emissions in flue gases were effective in reducing pollutions, legal liabilities and costs. Manufacturer's operating instructions should be followed to ensuring the design temperatures, residence time and turbulences condition were achieved and to avoid the facilities damages. Besides, properly trained equipment operators for both normal and emergency conditions was necessary where extreme care must be exercised when handling bottom ashes due to its hazardousness and when transporting to disposal sites as expressed by Kenya Law Reports (2012) and Corbitt (2004).

4.5.3 Incineration performance

The proper design and effective operations of an incinerator enables the safe destruction of wide ranges of waste materials. Moreover, the increased *CO* and *HC* in flue gases strongly indicated inappropriate incineration conditions in the furnaces. These improper conditions

could be adjusted by increasing raw air inlet to the kilns; reduction of flue gas recycling and slight increase of pressure below the grid as noted by Quina *et al.* (2011). Waste incineration at low moisture content, low loading, high operating temperature, high resident time and moderate turbulence led to complete combustion. Furthermore, the bottom ash with finest and grayish white residues was attributed to waste incineration at lowest loading rate of 15 kg/h, lowest moisture content of 15% and highest operating temperature of 900°C which depicted into good incineration performance. Besides, the wastes incineration at 900°C resulted into mean *CO*, *CO*₂ and *HC* emissions which were within the minimum limits of 10 ppm, 10% and 700 ppm, respectively as specified by the Environmental Management and Co-ordination Act-Kenya (1999). The smoke opacity status at the chimney exit and bottom ash residues are some of parameters used to measure incineration performance.

The appropriate incinerators design and continuous monitoring parameters for temperature, residence time and combustion air distribution assures the achievement of high combustion efficiencies. Achievement of complete combustion would be assessed based on ability of the alternative system to meet or exceed the Guideline Limits for carbon monoxide, hydrocarbon, smoke opacity, particulate matter, nitrogen oxides, dioxins and furans. Proponents of such alternative systems would be expected to provide thorough documentation, including test data generated by reputable testing agencies and verified using rigorous verification procedures as emphasized by Corbitt (2004). The detailed engineering drawings, specifications and calculations to support the design and operating parameters are required for the evaluations.

CHAPTER FIVE

CONCLUSION AND RECOMMENDATIONS

5.1 Conclusion

The solid wastes incineration disposal methods, constituted of complex processes involving economic factors, people's attitudes, governance issues and other such components which contributed to the release of different pollutants into the environment. The solid wastes from Njokerio, Ng' Ondu and Green Valley were characterized in terms of moisture content, volatile matters, ash content, fixed carbon, caloric value and density. Moreover, the solid wastes incineration at varying moisture contents, incinerator loading rates and operating temperature levels were determined whereas the smoke opacity and bottom ash qualities were assessed. The air flow patterns and velocity profiles simulation for small scale incinerators were also investigated and used in drawing conclusion and various recommendations made for future work in this section. The residential area under study, solid wastes had high densities caused by ash residues from jikos, leftover food, vegetables, peelings and waste water poured into the collection bins. Solid wastes with high calorific values including plastics, photocopying papers, cartons and dry wood have better combustion efficiency. The carbon monoxide (CO), carbon dioxide (CO_2) and hydrocarbon (HC) emissions increased linearly with increase in moisture content during solid wastes incineration. Moreover, the gas emissions of CO , CO_2 and HC were directly proportional to the incinerator loading rates towards a maximum value, but inversely proportional to operating temperature levels.

The solid wastes incineration at varying moisture content (MC) ranging from 15% through 75% produced mean flue gas emissions of CO ranging from 5 to 11 ppm, CO_2 from 5 to 14% and HC from 508 to 1168 ppm. Incineration of solid wastes above 45% of MC , contributed to higher mean HC emissions which exceeded the regulatory standards/limits. Therefore, when incinerating very wet solid garbage, the ignition burner should be set to remain on until it is completely burned. The higher moisture contents would prolong the wastes drying processes and weakening the combustion processes which demands use of auxiliary fuels. Therefore, wet putrescible materials need to separate in order to increase wastes heating values which in turn reduces emissions and energy consumption. The solid waste characterization including heating value, moisture content and other chemical properties highly affects the furnace functions and fugitive emissions. Wastes incineration at varying incinerator loading rates from 15 kg/h through 75 kg/h yielded mean CO ranging from 5 to 12 ppm, CO_2 from 5 to 14 % and HC from 252 to 1096 ppm. The incinerators waste loading rates above normal capacity contributed to high HC , CO and CO_2 which exceeded the emissions standards/limits and should be avoided.

Incinerating wastes at varying operating temperature levels from 180°C to 900°C produced mean flue gas emissions of *CO*, *CO*₂ and *HC* ranging from 14 to 5 ppm, 15 to 6% and 1253 to 316 ppm, respectively. The incinerator operating temperature levels above 720°C contributed to low mean *HC* emissions below 700 ppm which was within the regulatory standards. Therefore, operating temperatures is one of the key variables that determines the combustion conditions and it exert a large influence on emissions formation in wastes incineration system.

The presence of high levels of *HC* and *CO* in flue gases indicates incomplete combustion, whereas presences of bottom ash containing large pieces of unburned material is an indication of poor incineration performance. Incinerating wastes at low moisture contents, low loading rates and high operating temperatures yielded to finest and grayish white bottom ash residues which had low percentage of carbon indicating complete waste combustions. Incineration of wastes with opposite conditions resulted in to coarse and black bottom ashes signifying poor furnace processes. The physical and chemical properties of bottom ash depends upon the waste types, moisture contents, incinerator loading rates and operating temperature levels.

The wastes with high moisture contents and high incinerator loading rates contributed to high emissions resulted into dark and dense smoke but are indirectly related to the operating temperatures. Incinerating waste at higher operating temperature levels, high residence/holding time and moderate air turbulence, would result to complete combustion. Wastes incineration with high fixed carbon and calorific values caused heavy and dense smoke opacity, leading to large amounts of fine particulate matter being released into the environment.

The simulations for Egerton University dispensary incinerator showed evenly of the gases flow and velocity profiles distributions, indicating best incineration performance. It had a maximum velocity of 5.15 m/s at chimney exit and 1.92 m/s at air-entry port. Moreover, the incinerator at Green Valley areas was better in performance as compared to that of Community Resource Centre (CRC) which was very inefficient due poor design. The incinerator at CRC had a very narrow air inlet port, very long and narrow chimney, no dome shaped at air entry and at stack resulting to flue gases flowing backward. Also, the performances for square, rectangular and circular based incinerator models were better than that of triangular-based. Circular based incinerator model was the best whereas the triangular-based design produced the worst incineration performance.

The two small-scale incinerators at Egerton University Dispensary and the domestic one from the same neighbourhood at Green Valley area were able to meet the Environmental Management and Co-Ordination Act, on Ambient air quality standards. The other small-scale incinerators were unable to meet the emissions standards/limits. Moreover, the small-scale

incinerators cannot fully meet the emissions standards/limits since they are not incorporate with air pollution control devices although, when operated effectively can lower the possible emissions. Some of effective practices includes good incinerator design ensuring combustion conditions were appropriate, detailed construction dimensional plans and proper operational schedules ensuring appropriate start-up and cool-down procedures with inspection and planned maintenance. The incineration combustion efficiency improvement through the continuous emission monitoring would effectively reduce the flue gas emissions and increase the quality of bottom ash residues.

5.2 Recommendations

The current waste management practice where solid waste materials are all mixed together at generation, collection, transportation and finally disposal should extremely be discouraged. Solid waste segregation at source should be the standard practice in all households and medical facilities. If proper segregation is achieved through training, clear standards, and tough enforcement, then resources can be used to management the small portions of waste stream needing special treatment. Open burning of solid waste is widely used by area residents, as a means of disposal and there should be a rigorous campaign lobbying for an end to the practice. In order to broaden the understanding of performance of small-scale incinerators and emission levels of flue gases, further research is recommended in the following areas:

- i. Optimization of process parameters such as incinerator feeding rate, moisture content and incinerator operating temperature and flue gas flow patterns and velocity vectors.
- ii. Mathematical modelling and simulations of turbulence-thermal interaction in solid waste incinerators.
- iii. Construction of the designed rectangular, square, circular and triangular base shaped incinerator models of equal capacity and test them for incineration optimization.

REFERENCES

- Aguilar-Virgen, Q., Armijo-de Vega, C., Taboada-González, P., & Ojeda-Benítez, S. (2010). Municipal solid waste generation and characterization in Ensenada, México. *The Open Waste Management Journal*, 3, 140-145.
- Alhassan, H. M., & Tanko, A. M. (2012). Characterization of solid waste incinerator bottom ash and the potential for its use. *International Journal of Engineering Research and Applications*, 2(4), 516-522.
- Ansah, B. (2014). *Characterization of municipal solid waste in three selected communities in the Tarkwa Township of Nsuaem municipality in Ghana*. (Masters of Science in Environmental Science), Nsuaem, Ghana.
- Arsad, A., Sulaiman, H., & Rahmat, A. (2006). *Combustion behaviour of poultry and plastics waste in as bench scale combustor*. (Masters of Science in Environmental Science), Penyelidik University Technology, Malaysia.
- Ashley, J. (2013). *Visible emissions observer training manual*: Eastern Technical Associates, Washington DC, USA.
- ASTM D240-02. (2013). Standard test method for heat of combustion of liquid fuels by bomb calorimeter: American Society for Testing of Materials, Washington, DC.
- ASTM E871-82. (2013). Standard Test Method for Moisture Analysis of Particulate Wood Fuels. American Society for Testing of Materials, Washington, DC.
- ASTM E872-82. (2013). *Standard test method for volatile matter in analysis of particulate wood fuels*. American Society for Testing of Materials, Washington, DC.
- ASTM E1534-93. (2013). Standard Test Method for Determination of Ash Content of Particulate Wood Fuels. American Society for Testing of Materials, Washington, DC.
- Astrup, T., Riber, C., & Pedersen, A. (2011). Incinerator performance - Effects of changes in waste input and furnace operation on air emissions and residues. *Waste Management and Research*, 1, 1-12.
- Ayaa, F., Mtui, P., Banadda, N., & Van Impe, J. (2014). Design and computational fluid dynamic modeling of a municipal solid waste incinerator for Kampala city, Uganda. *American Journal of Energy Engineering*, 2(3), 80-86.
- Ayeleru, O., Ntuli, F., & Mbohwa, C. (2016). *Utilization of organic fraction of municipal solid waste as compost*. Paper presented at the Proceedings of World Congress on Engineering and Computer Science, Florida, South Africa.

- Basham, D., Wright, J., Ferguson, K., & Moy, G. (2004). *Solid waste incineration-Technical instructions*. U.S. Army Corps, Unified Facilities Criteria, Washington, DC.
- Batterman, S. (2004). *Assessment of small-scale incinerators for health care waste*. Environmental Health Sciences, University of Michigan, Geneva, Switzerland.
- Bernardo, M. (2011). *Physico-chemical characterization of chars produced in co-pyrolysis of wastes and possible routes of valorisation*. (Master of Energy and Bioenergy), University of Coimbra, Portugal.
- Bichi, M., & Amatobi, D. (2013). Characterization of household solid wastes generated in Sabon-Gari in Nigeria. *American Journal of Research Communication*, 1(4), 165-171.
- Botter, D., Jørgensen, B., & Peres, A. (2002). A longitudinal study of mortality and air pollution for São Paulo, Brazil. *Journal of Exposure Science and Environmental Epidemiology*, 12(5), 335-343.
- Bradfield, F. (2014). *Examination of thermal properties of municipal solid waste and scalability of its pyrolysis*. (Master of Engineering in Chemical Engineering), Stellenbosch University, Stellenbosch.
- Brosch, B., Scherer, V., & Wirtz, S. (2014). Simulation of MSW incineration in grate firing systems with a particle based novel Discrete Element Method. *International Journal for Electricity and Heat Generation*, 1(2), 75-83.
- Buekens, A., & Cen, K. (2011). Waste incineration, Poly-Vinyl-Chloride (PVC), and dioxins. *Journal of Material Cycles and Waste Management*, 13(3), 190-197.
- Bujak, J. (2010). Experimental study of the lower heating value of medical waste. *Polish Journal of Environmental Studies*, 19(6), 1151-1158.
- Carson, P. (2002). *Hazardous chemicals handbook*: Elsevier, Kidlington, UK.
- Castellani, B., Morini, E., Filipponi, M., Nicolini, A., & Rossi, F. (2014). Comparative analysis of monitoring devices for particulate content in exhaust gases *Journal of Sustainability*, 6 (1), 4287-4307.
- Chang, C., Wang, C., Mui, D., Cheng, M., & Chiang, H. (2009). Characteristics of elements in waste ashes from a solid waste incinerator in Taiwan. *Journal of hazardous materials*, 165(1-3), 766-773.
- Chang, Y., Fan, W., Dai, W., Hsi, H., Wu, C., & Chen, C. (2011). Characteristics of PolyChlorinatedDibenzo-p-Dioxins (PCDD/F) content in fly ash discharged from municipal solid waste incinerators. *Journal of hazardous materials*, 192(2), 521-529.
- Chanson, H. (2009). *Applied hydrodynamics: An introduction to ideal and real fluid flows*: CRC Press, Washington, D.C.

- Chen, H., Chang, N., Chen, J., & Tsai, S. (2010). Environmental performance evaluation of large-scale municipal solid waste incinerators using data envelopment analysis. *Waste Management Journal*, 30(7), 1371-1381.
- Chen, T., & Lin, C. (2010). Carbon dioxide emission from municipal solid waste incinerator: IPCC formula estimation and flue gas measurement. *Journal of Environmental Engineering and Management*, 20(1), 9-17.
- Chen, W., Han, J., Qin, L., Furuuchi, M., & Mitsuhiko, H. (2014). The emission characteristics of PAHs during coal and sewage sludge co-combustion in a drop tube furnace. *Aerosol and Air Quality Research*, 14, 1160–1167.
- Cogut, A. (2016). *Open burning of waste: A global health disaster*. R20 Regions of Climate Action.
- Conesa, J., Font, R., Fullana, A., Martín-Gullón, I., Aracil, I., & Gómez-Rico, M. (2009). Comparison between emissions from the pyrolysis and combustion of different wastes. *Journal of Analytical and Applied Pyrolysis*, 84(1), 95-102.
- Corbitt, R. A. (2004). *Standard Handbook of Environmental Engineering* (second ed.): McGraw-Hill Companies, Indianapolis, United State of America.
- Das, S., & Bhattacharyya, B. (2013). *Municipal solid waste characteristics and management in Kolkata, India*. Paper presented at the International Conference on Industrial Engineering and Management, Kolkata, India.
- De Medina, S., Castillo, G., & Romero, L. (2013). Physical and chemical characteristics of municipal solid waste in a rural locality-A case study, Mexico. *International Journal of Business, Humanities and Technology*, 3(8), 117-122.
- Denda, T., Nakayama, T., & Iwasaki, T. (2014). Numerical simulation of combustion behavior in stoker-type incineration system. *JFE Technical Report*, 1, 139-144.
- Doka, G. (2003). *Waste Incineration Part II - Report on Life Cycle Inventories of Waste Treatment Services*. Dübendorf, Switzerland.
- Dong, J., Chi, Y., Tang, Y., Ni, M., & Nzihou, A. (2016). Effect of operating parameters and moisture content on MSW pyrolysis and gasification. *Energy and Fuels, American Chemical Society*, 30(5), 3994-4001.
- Douglas, C. (2013). *Design and analysis of experiments* (8th ed.): John Wiley and Sons, River Street, Hoboken.
- Dyke, P. H., Foan, C., & Fiedler, H. (2003). PCB and PAH releases from power stations and waste incineration processes in the UK. *Chemosphere*, 50(4), 469-480.

- Earle, J. (2003). Rotary kiln incineration of hazardous wastes; Pilot-scale studies at Louisiana State University. USA.
- Eastop, T., & Mc-Conkey, A. (2002). *Applied thermodynamics for engineering and technologists* (5th ed.): Pearson Education Ltd, Delhi, India.
- El-Mahallawy, F., & Habik, S. (2002). *Fundamentals and technology of combustion*: Elsevier, Kidlington, UK.
- ENVILEAD. (2005). *Waste incineration activities in Nairobi that release dioxin and furan into environment*. International POPs Elimination Project (IPEP), Kenya.
- Environment Canada. (2013). *Canada's emissions trends*. Ministry of Environment. Canada.
- Environmental Management and Co-ordination Act- Kenya. (1999). *The Environmental Management and Co-ordination (Air Quality) Regulations* Government of Kenya.
- Fang, G. C., Chang, K. F., & Lu, C. (2004). Estimation of PAHs dry deposition and BAP toxic equivalency factors (TEFs) study at urban, industrial park and rural sampling sites in central Taiwan, Taichung. *Chemosphere*, 55, 787–796.
- Fobil, J. N., Carboo, D., & Armah, N. A. (2005). Evaluation of municipal solid wastes (MSW) for utilisation in energy production in developing countries. *International journal of environmental technology and management*, 5(1), 76-86.
- Gaska, K., & Generowicz, A. (2017). Advanced computational methods in component-oriented modelling of municipal solid waste incineration processes. *Architecture, Civil Engineering and Environment*, 3(4), 19-27.
- Gaurav, G., & Khanam, S. (2017). Computational fluid dynamics analysis of sponge iron rotary kiln. *Case Studies in Thermal Engineering*, 9, 14-27.
- Genick, B. M. (2007). *Fundamentals of Compressible Fluid Mechanics*. Minneapolis, USA.
- Government of India. (2009). *Performance evaluation and monitoring of common hazardous waste and disposal facilities including hazardous waste incinerators*. Hazardous Waste Management, Delhi, India.
- Government of Nunavut. (2012). *Environmental Guideline for Burning and Incineration of Solid Waste*. Environmental Protection Department, Iqaluit, Nunavut.
- Gu, Y., Ozel, A., Kolehmainen, J., & Sundaresan, S. (2019). Computationally generated constitutive models for particle phase rheology in gas-fluidized suspensions. *Journal of Fluid Mechanics, Cambridge University Press*, 860, 318-349.
- Guendehou, G., Koch, M., Hockstad, L., & Yamada, M. (2006). Incineration and open burning of waste. *IPCC Guidelines for National Greenhouse Gas Inventories; Intergovernmental Panel on Climate Change: Geneva, Switzerland*, 1, 77-102.

- Huai, X., Xu, W., Qu, Z., Li, Z., Zhang, F., Xiang, G., Zhu, S., & Chen, G. (2008). Numerical simulation of municipal solid waste combustion in a novel two-stage reciprocating incinerator. *Waste management*, 28(1), 15-29.
- Huang, C., Yang, W., Ma, H., & Song, Y. (2006). Potential of recycling and reusing municipal solid waste incinerator ash in Taiwan. *Waste management*, 26(9), 979-987.
- Huang, K., Wu, M., Tsai, J., Lin, D., Chen, S., & Lee, W. (2016). Effect of operating conditions on PAHs emission from a single hydrogen-oxygen PEM fuel cell. *Aerosol Air Quality Research*, 16, 2186-2197.
- Hussain, A., Nasir Ani, F., Sulaiman, N., & Fadzil Adnan, M. (2006). Combustion modelling of an industrial municipal waste combustor in Malaysia. *International journal of environmental studies*, 63(3), 313-329.
- Kalanatarifard, A., & Yang, G. (2012). Identification of the municipal solid waste characteristics and potential of plastic recovery at Bakri Landfill, Muar, Malaysia. *Journal of Sustainable Development*, 5(7), 11-17.
- Katiyar, R., Suresh, S., & Sharma, A. (2013). Characterisation of municipal solid waste generated by the city of Bhopal, India. *International Journal of Chemical Technology Research*, 5(2), 623-628.
- Kenya Law Reports. (2012). *Environmental Management and Co-Ordination Act No. 8 Cap. 387 of 1999*. National Council for Law Reporting, Kenya
- Khamala, E. M., & Alex, A. A. (2013). Municipal solid waste composition and characteristics relevant to the waste-to-energy disposal method for Nairobi city. *Global Journal of Engineering, design and technology*, 2, 1-6.
- Kim, K., Kim, D., Hong, J., & Jo, Y. (2009). Evaluation of emission factor of air pollutants emitted from open burning of MSW. *J. Mater. Cycle Waste Manag*, 26(2), 161-167.
- Kothari, C. (2004). *Research Methodology-Methods and Techniques*: New Age International (P) Ltd, New Delhi, India.
- Kuleape, R., Cobbina, S., Dampare, S., Duwiejuah, A., & Asare, W. (2014). Assessment of energy recovery potentials of solid waste generated in Akosombo, Ghana. *African Journal of Environmental Science and Technology*, 8(5), 297-305.
- Kumar, S., Aggarwal, S., Sarangi, B., Malherbe, J., Barre, J., & Donard, O. (2017). Understanding influence of open-waste burning on urban aerosols using metal tracers and lead isotopic composition. *Aerosol and Air Quality Research*, 18, 2433-2446.

- Lai, Y. C., Tsai, C. H., Chen, Y. L., & Chang-Chien, G. P. (2017). Distribution and sources of atmospheric polycyclic aromatic hydrocarbons at an industrial region in Kaohsiung, Taiwan. *Aerosol and Air Quality Research*, 17(2), 776-787.
- Lee, W., Liow, M., Tsai, P., & Hsieh, L. (2002). Emission of polycyclic aromatic hydrocarbons from medical incinerators. *Atmospheric Environment*, 36(5), 781-790.
- Liamsanguan, C., & Gheewala, S. H. (2008). The holistic impact of integrated solid waste management on greenhouse gas emissions in Phuket. *Journal of Cleaner Production*, 16(17), 1865-1871.
- Lima, R., & Bachmann, R. (2002). Pollutant emissions from modern incinerators. *International journal of environment and pollution*, 18(4), 336-345.
- Lin, H., & Ma, X. (2012). Simulation of co-incineration of sewage sludge with municipal solid waste in a grate furnace incinerator. *Waste management*, 32(3), 561-567.
- Lombardi, F., Lategano, E., Cordiner, S., & Torretta, V. (2013). Waste incineration in rotary kilns: a new simulation combustion tool to support design and technical change. *Waste Management & Research*, 31(7), 739-750.
- Loretsen, L., & Burgeat, E. (2004). *Assuring Environmental Compliance- A toolkit for building better environmental inspectorates in Eastern Europe, Caucasus, and Central Asia*: Organisation for Economic Co-operation and Development, Canada.
- Macknick, J. (2011). Energy and carbon dioxide emission data uncertainties. *Journal of Carbon Management*, 2(2), 189-205.
- Manahan, S. (2017). *Environmental chemistry handbook*: CRC press, Washington, D.C.
- Manyele, S. V., Kagonji, I. S., & Mrisho, J. (2011). Assessment of medical waste incinerator performance based on physical characteristics of ashes. *Engineering*, 3(10), 1045-1053.
- Matee, V., & Manyele, S. (2015). Performance of a large-scale medical waste incinerator in a referral hospital. *Engineering*, 7(10), 676-690.
- Miezah, K., Obiri-Danso, K., Kádár, Z., Fei-Baffoe, B., & Mensah, M. (2015). Municipal solid waste characterization and quantification as a measure towards effective waste management in Ghana. *Waste management*, 46, 15-27.
- Minutillo, M., Perna, A., & Di Bona, D. (2009). Modelling and performance analysis of an integrated plasma gasification combined cycle (IPGCC) power plant. *Energy Conversion and Management*, 50(11), 2837-2842.
- Moora, H., Voronova, V., & Uselyte, R. (2012). Incineration of municipal solid waste in the Baltic states: influencing factors and perspectives. *Waste to Energy*, 1, 237-260.

- Morrin, S., Lettieri, P., Chapman, C., & Mazzei, L. (2012). Two stage fluid bed-plasma gasification process for solid waste valorisation: Technical review and preliminary thermodynamic modelling of sulphur emissions. *Waste management*, 32(4), 676-684.
- Mousavi, M., Taymouri, A., & Ghaffavian, V. (2009). Transient mass transfer modeling and simulation of polybrominated diphenyl ethers combustion in incinerators. *International Journal of Environmental Science and Technology*, 6(3), 499-508.
- Muriithi, G. (2009). *Carbon dioxide sequestration using brine impacted fly fish*. (Master Science in Chemistry), University of the Western Cape, South Africa.
- Musa, O., Chen, X., Li, Y., Li, W., & Liao, W. (2019). Unsteady simulation of ignition of turbulent reactive swirling flow of Novel design of solid-fuel Ramjet motor. *Energies*, 12(13), 1-32.
- Musale, S., & Padhya, H. (2013). Process modeling and simulation in plasma technology-An innovative approach towards sustainable solution for solid waste treatment. *International Refereed Journal of Engineering and Science*, 2(4), 50-54.
- N'wutchi, K., Igo, S., Palm, K., Atchonouglo, K., Ndiho, A., Ouedraogo, I., Banna, M., & Zeghmati, B. (2014). Numerical simulation of turbulence-radiation Interaction in a cylindrical incinerator of the smokes produced by household wastes. *International Journal of Scientific & Technology Research*, 3(1), 324-331.
- Nabertherm, G. (2016). *Operating Instructions-Laboratory Furnaces (Muffle Furnaces)*. Nabertherm GmbH, Lilienthal, Germany.
- NEMA Newsletter. (2019). World environment day 5th June Celebration. *The National Environment Management Newsletter-Uganda*, 22(1), 1-16.
- Neuwahl, F., Cusano, G., Benavides, J., Holbrook, S., & Roudier, S. (2019). *Best Available Techniques (BAT) Reference Document for Waste Incineration (Integrated Pollution Prevention and Control)*. European Commission, Seville, Spain.
- Niessen, W. (2010). *Combustion and incineration processes -Applications in environmental engineering*: CRC Press, Washington, D.C.
- Oehlert, G. (2010). *A first course in design and analysis of experiments*: University of Minnesota-Design Expert, England.
- Ogwueleka, T. (2009). Municipal solid waste characteristics and management in Nigeria. *Journal of Environmental Health Science & Engineering*, 6(3), 173-180.
- Omari, A. M. (2013). Characterization of municipal solid waste for energy recovery. *Journal of multidisciplinary engineering science and technology*, 2(1), 230-237.

- Omari, A. M., Njau, K. N., John, G. R., Kihedu, J. H., & Mtui, P. L. (2015). Mass and energy balance for fixed bed incinerators. *Journal of Multi- disciplinary Engineering Science and Technology*, 2(9), 2365-2373.
- Ombacho, K. (2009). *Health Care Waste Management-Incinerator Operator Manual*. Ministry of Public Health and Sanitation, Nairobi, Kenya.
- Osei-Mensah, P., Adjaottor, A., & Owusu-Boateng, G. (2014). Characterization of Solid Waste in the Atwima-Nwabiagya District of the Ashanti Region, Kumasi-Ghana. *International Journal of Waste Management and Technology*, 2(1), 1-14.
- Oumarou, M. (2015). Experimental Characterization of Municipal Solid Waste for Energy Production in Niger Republic. *American Journal of Energy Research*, 3(2), 32-36.
- Oumarou, M., Dauda, M., Abdulrahim, A., & Abubakar, A. (2012). Characterization and generation of municipal solid waste in north central Nigeria. *International Journal of Modern Engineering Research*, 2(5), 3669-3672.
- Park, Y. K., Kim, W., & Jo, Y. M. (2013). Release of harmful air pollutants from open burning of domestic municipal solid wastes in a metropolitan area of Korea. *Aerosol Air Qual Res*, 13(4), 1365-1372.
- Parr, S. (2010). *Semi-Micro Oxygen Bomb Calorimeter Operating Instruction Manual*. Parr Instrument Company, Moline, Illinois-USA.
- Petridis, K., & Dey, P. K. (2018). Measuring incineration plants' performance using combined data envelopment analysis, goal programming and mixed integer linear programming. *Annals of Operations Research*, 267(1-2), 467-491.
- Pinasseau, A., Zerger, B., Roth, J., Canova, M., & Roudier, S. (2018). *Best Available Techniques (BAT) Reference Document for Waste Treatment (Integrated Pollution Prevention and control)*. European Union, Luxembourg.
- Pushpendra, S., & Srivastava, A. (2017). CFD Analysis on fluidized bed gasification of rice husk and rice straw. *Open Access Library Journal*, 4, 1-10.
- Quina, M., Bordado, J., & Quinta-Ferreira, R. (2011). Air pollution control in municipal solid waste incinerators. *Impact of Air Pollution on Health, Economy and Environment, Shanghai, China*, 1, 331-358.
- Rajput, R. (2007). *Engineering Thermodynamics*: Laxmi Publications (P) Ltd, Delhi, India.
- Reddy, C., Mohanty, S., & Shaik, R. (2018). Physical, chemical and geotechnical characterization of fly ash, bottom ash and municipal solid waste from Telangana State in India. *International Journal of Geo-Engineering*, 9(23), 1-23.

- Rimaitytė, I., Denafas, G., Martuzevicius, D., & Kavaliauskas, A. (2010). Energy and environmental indicators of MSW incineration-toward selection of an optimal waste management system. *Polish Journal of Environmental Studies*, 19(5), 989-997.
- Rogers, D. E., & Brent, A. C. (2006). Small-scale medical waste incinerators—experiences and trials in South Africa. *Waste management*, 26(11), 1229-1236.
- Rufo, L., & Rufo J, C. (2004). *Clean incineration of solid waste: A cost-benefit analysis for Manila*: Regional Office for Southeast and East Asia, Singapore.
- Ryu, C., Shin, D., & Choi, S. (2002). Combined simulation of combustion and gas flow in a grate-type incinerator. *Journal of Air and Waste Management*, 52(2), 189-197.
- Sachdev, S., Pareek, S., Mahadevan, B., & Deshpande, A. (2012). *Modeling and simulation of single phase fluid flow and heat transfer in packed beds*. Paper presented at the Computational Fluid Dynamics-COMSOL Multiphysics, Bangalore.
- Saeed, M. O., Hassan, M. N., & Mujeebu, M. A. (2009). Assessment of municipal solid waste generation and recyclable materials potential in Kuala Lumpur, Malaysia. *Waste management*, 29(7), 2209-2213.
- Salam, H. (2013). Operating and emission characteristics of a novel design four chambers infectious meat incinerator. *International Journal of Research in Engineering and Technology*, 2(11), 322-328.
- Salami, L., Susu, A., Patinvoh, R., & Olafadehan, O. (2011). Characterisation study of solid wastes: Case of Lagos state. *International Journal of Applied Science and Technology*, 1(3), 47-52.
- Saripalli, R., Wang, T., & Day, B. (2005). *Simulation of combustion and thermal flow in an industrial boiler*. Paper presented at the 27th Proceeding on Industrial Energy and Technology Conference, Hamburg.
- Sørum, L., Grønli, M., & Hustad, J. (2001). Pyrolysis characteristics and kinetics of municipal solid wastes. *Fuel*, 80(9), 1217-1227.
- Straka, M., Rosova, A., Malindzakova, M., Khouri, S., & Culkova, K. (2018). Evaluating the waste incineration process for sustainable development through modelling, logistics, and simulation. *Polish Journal of Environmental Studies*, 27(6), 2739-2748.
- Sun, R., Ismail, T., Ren, X., & El-Salam, M. (2015). CFD Study on effect of primary air on combustion of simulated MSW process in fixed bed. *International Journal of Mechanical, Industrial, Mechatronic and Manufacturing Engineering*, 9(4), 613-621.

- Suthapanich, W. (2014). *Characterization and assessment of municipal solid waste for energy recovery options in Phetchaburi, Thailand*. (MSc in Environmental Engineering), Asian Institute of Technology, Resources and Development, Thailand.
- Talsania, P., & Modi, N. (2019). A review of waste generation, characterisation and solid waste management practices using bottoms-up approach in educational buildings. *International Journal of Research and Analytical Reviews-IJRAR*, 6(2), 866-869.
- Tangri, N. (2003). *Waste incineration - A dying technology*. Global Alliance for Incinerator Alternatives-Quezon City, Philippines.
- Tao, H., He, P., Zhang, Y., & Sun, W. (2017). Performance evaluation of circulating fluidized bed incineration of municipal solid waste by multivariate outlier detection in China. *Frontiers of Environmental Science and Engineering*, 11(6), 4-10.
- Taylor, E. (2003). *Rapid assessment of small-scale incinerators - Final draft*. Kenya.
- Tchobanoglous, G., & Kreith, F. (2002). *Handbook of solid waste management*: McGraw-Hill Companies, Inc. New York, USA.
- Thompson, J., & Anthony, H. (2005). The health effects of waste incinerators. *Journal of Nutritional and Environmental Medicine*, 15(2-3), 115-156.
- Ujam, A., & Eboh, F. (2012). Flue gas analysis of a small-scale municipal solid waste-fired steam generator. *International Journal Computer Engineering*, 2, 8-20.
- UNEP. (2008). *Guidelines on best available techniques and provisional guidance on best environmental practices*. Relevant to Article 5 and Annex C of Stockholm Convention on Persistent Organic Pollutants, Geneva, Switzerland.
- UNEP. (2019). *Draft updated technical guidelines on incineration on land*. Paper presented at the Conference of Parties to Basel Convention on Control of Transboundary Movements of Hazardous Wastes and their Disposal, Geneva, Switzerland.
- USCAR. (2014). *Greenhouse gas inventory. U.S. Climate action report*. Washington, DC.
- USEIA. (2011). *Emissions of greenhouse gases in United States*. U.S. Energy Information Administration: Washington, DC.
- Van Caneghem, J., Brems, A., Lievens, P., Block, C., Billen, P., Vermeulen, I., & Vandecasteele, C. (2012). Fluidized bed waste incinerators: Design, operational and environmental issues. *Progress in Energy and Combustion Science*, 38(4), 551-582.
- Wang, F.-H., Zhang, F., Chen, Y.-J., Gao, J., & Zhao, B. (2015). A comparative study on heavy metal solidification/stabilization performance of four chemical solidifying agents in MSW incineration fly ash. *Journal of hazardous materials*, 300, 451-458.

- White, R., & Heckenberg, D. (2012). *Legislation, regulatory models and approaches to compliance and enforcement*. University of Tasmania, Research Council, Australia.
- Wu, S., Yang, B., Wang, X., Yuan, C., & Hong, H. (2014). Polycyclic aromatic hydrocarbons in the atmosphere of two subtropical cities in Southeast China: Seasonal variation and gas/particle partitioning. *Aerosol Air Quality Research*, 14, 1232–1246.
- Würdemann, M., & Van-Veen, J. (2002). *Dutch notes on BAT for the incineration of waste*: Information Centre for Environmental Licensing, Hague, Netherlands.
- Xie, R., Lu, J., Li, J., & Yin, J. (2010). A burning experiment study of an integral medical waste incinerator. *Energy and Power Engineering*, 2, 175-181.
- Xin-gang, Z., Gui-wu, J., Ang, L., & Yun, L. (2016). Technology, cost, a performance of waste-to-energy incineration industry in China. *Renewable and Sustainable Energy Reviews*, 55, 115-130.
- Yang, H., & Chen, C. (2004). Emission inventory and sources of polycyclic aromatic hydrocarbons in atmosphere at a suburban area in Taiwan. *Chemosphere*, 56, 879-887.
- Yang, Y., Ryu, C., Goodfellow, J., & Swithenbank, J. (2004). Modelling waste combustion in grate furnaces. *Process Safety and Environmental Protection*, 82(3), 208-222.
- Yildiz, S., Yaman, C., Demir, G., Ozcan, H. K., Coban, A., Okten, H. E., Sezer, K., & Goren, S. (2013). Characterization of municipal solid waste in Istanbul, Turkey. *Environmental Progress & Sustainable Energy*, 32(3), 734-739.
- You, X. (2008). Polycyclic aromatic hydrocarbon emission from co-firing municipal solid waste and coal in a fluidized bed incinerator. *Waste management*, 28(9), 1543-1551.
- Zhang, C. (2012). *Assessing greenhouse gas emission from waste management in EU countries*. (Master of Science), University of Jyväskylä, England.
- Zhang, Y., Li, Q., Meng, A., & Chen, C. (2010). Carbon monoxide formation and emissions during waste incineration in a grate-circulating fluidized bed incinerator. *Waste Management and Research*, 29(3), 294-308.
- Zhu, J., Chen, L., Fang, J., & Shi, B. (2013). An integrated process investigation of self-sustaining incineration in a novel waste incinerator: Drying, pyrolysis, gasification, and combustion of sludge-plastic blends. *International Journal of Water Resources and Environmental Engineering*, 5(12), 648-658.

APPENDIX I

Dumpsite, Incinerators, Gas Analyzer and Model Simulations



Dumpsites at Ng'onde areas collection bins. Note the high proportion of polythene papers.
Plate A1.1: Stone built collection bin at Ng'onde areas damped with waste.

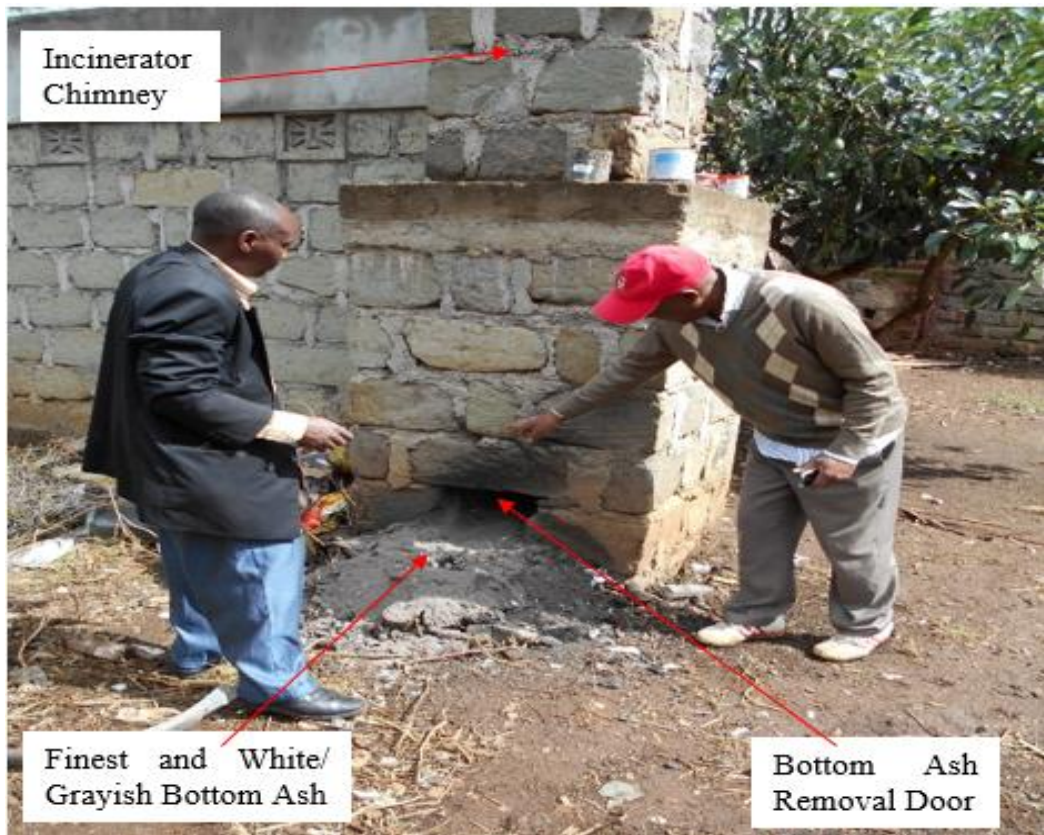

Researcher and Supervisor checking on bottom ash quality
Plate A1.2: Small-scale domestic incinerators at Green Valley areas

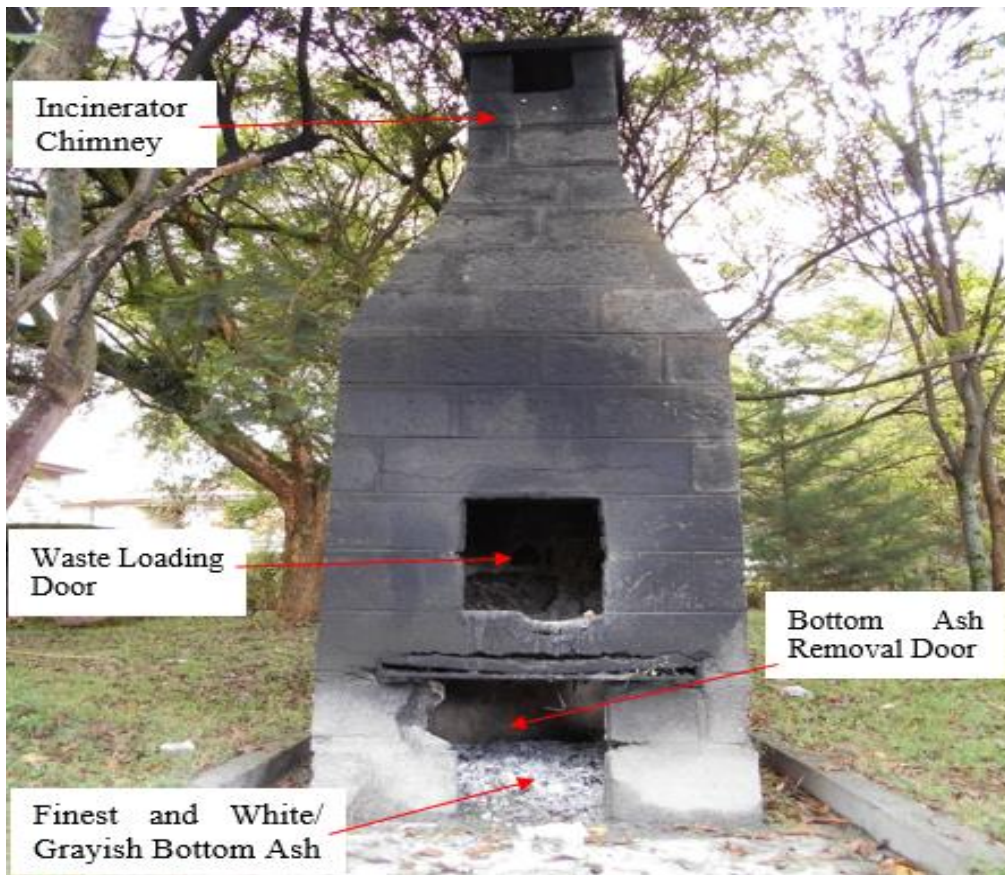

Plate A1.3: Good performance Small-scale incinerator at Egerton University dispensary

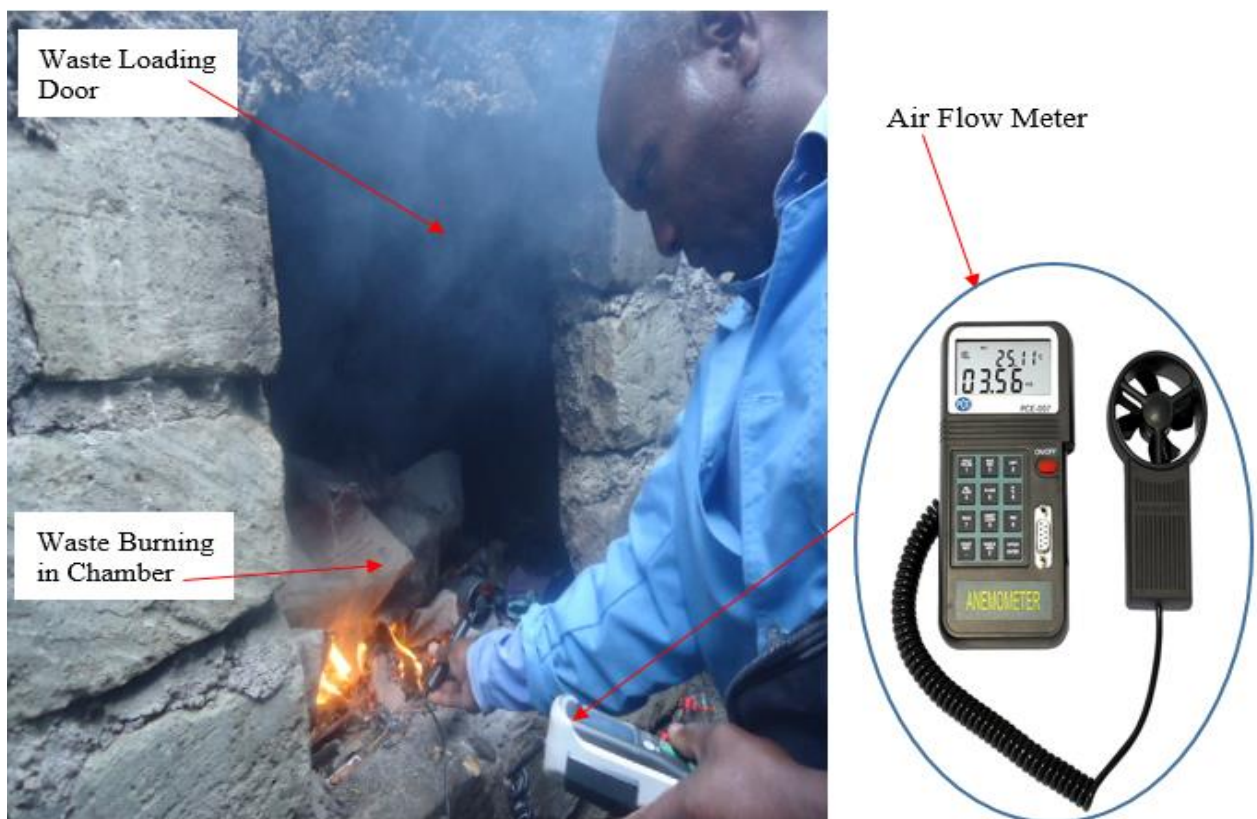
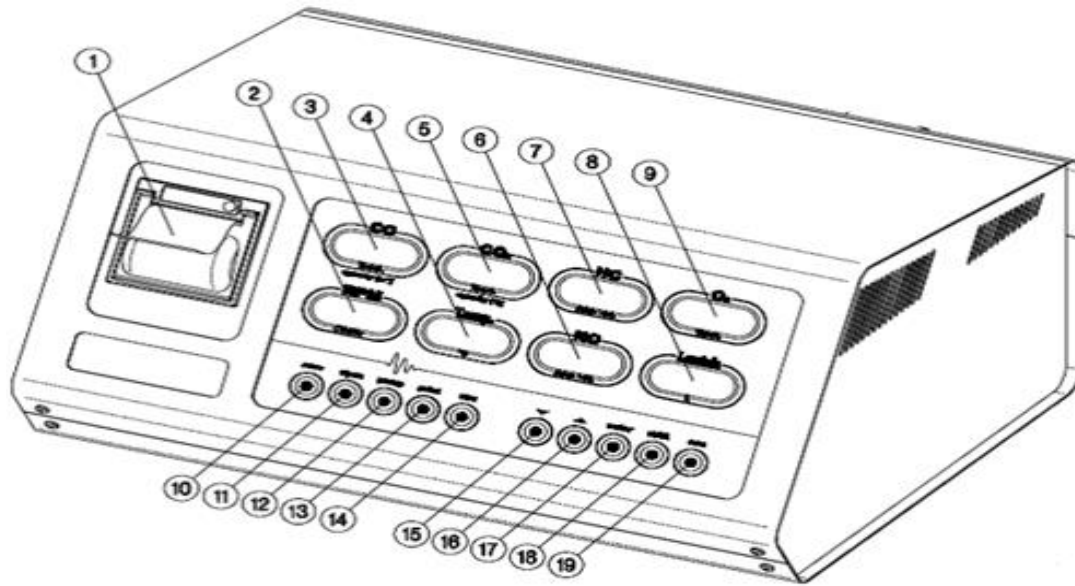
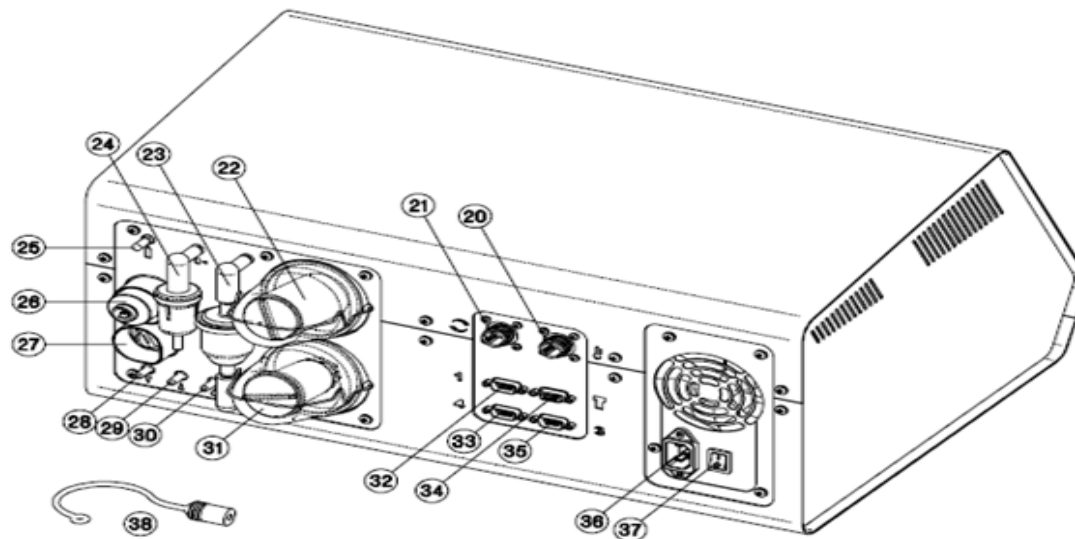

Plate A1.4: Air flow measurement into a small-scale incinerator at Stalla Hostel.



- | | | | | |
|----------------|---------------------------|--------------------------|------------------|---------------|
| 1-Printer | 5-CO ₂ display | 9-O ₂ display | 13-Print key | 17-Enter key |
| 2-RPM display | 6-NO _x display | 10-Zero key | 14-Auxiliary key | 18-Shift key |
| 3-CO display | 7-HC display | 11-Calibration | 15-Cursor key | 19-Escape key |
| 4-Temp display | 8-Lambda display | 12-Pump key | 16-Cursor key | |

Figure A1.1: Front view of the flue gas analyser.



- | | | | |
|----------------------|---------------------------|------------------------------------|-----------------------------|
| 20-Temp probe socket | 25-Flue gas inlet | 30-Condensation drain | 35-NO _x terminal |
| 21-Induction socket | 26-O ₂ sensor | 31-Condens separator | 36-Power socket |
| 22-Condens glass | 27-NO _x sensor | 32-Computer terminal | 37-Main power switch |
| 23-Condens air inlet | 28-Flue gas outlet | 33-NO _x sensor terminal | 38-Seal test plug |
| 24-Air inlet | 29-Flue-probe inlet | 34-Power terminal sockets | |

Figure A1.2: Rear view of the flue gas analyser.

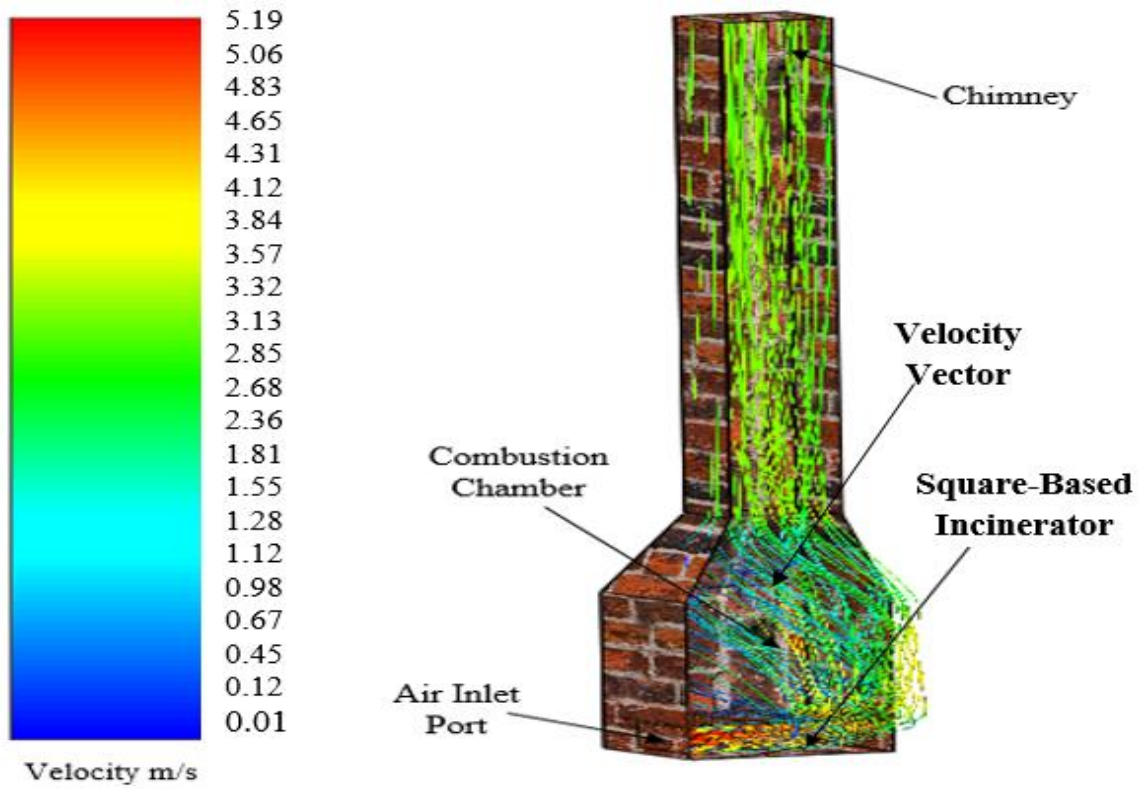

Figure A1.3: Square based incinerator model air flow patterns and velocity profiles.

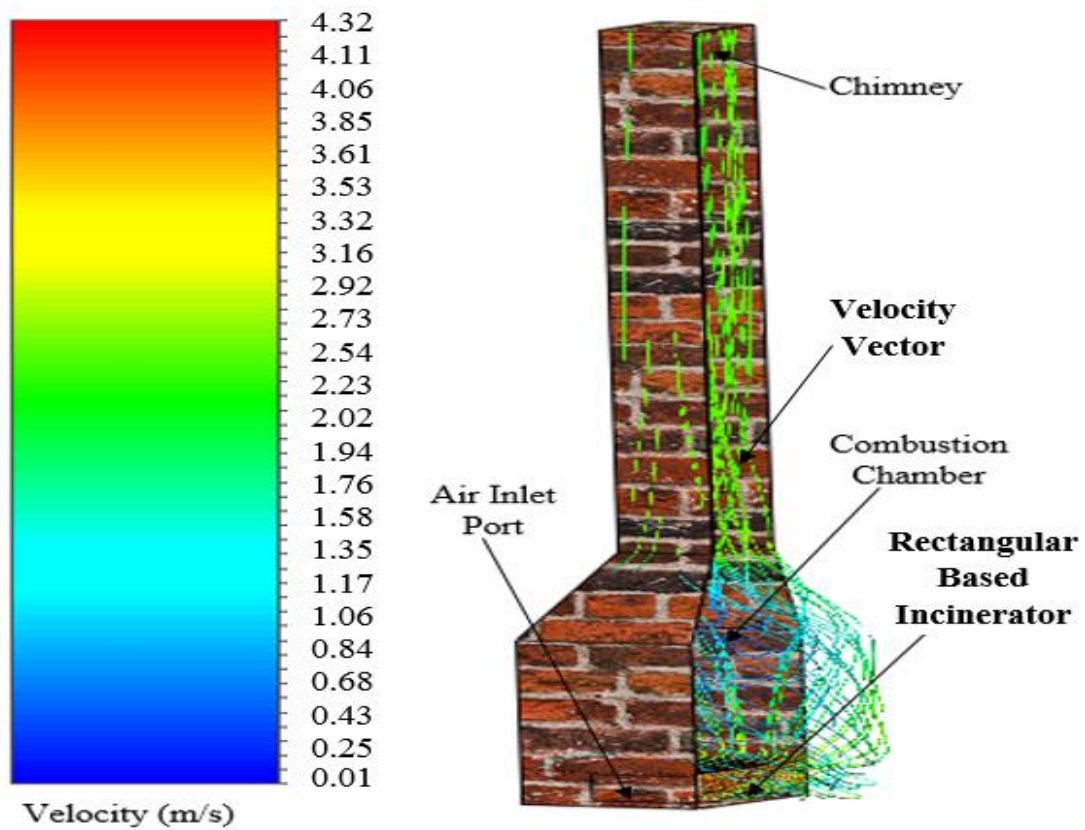

Figure A1.4: Rectangular incinerator model airflow patterns and velocity profiles.

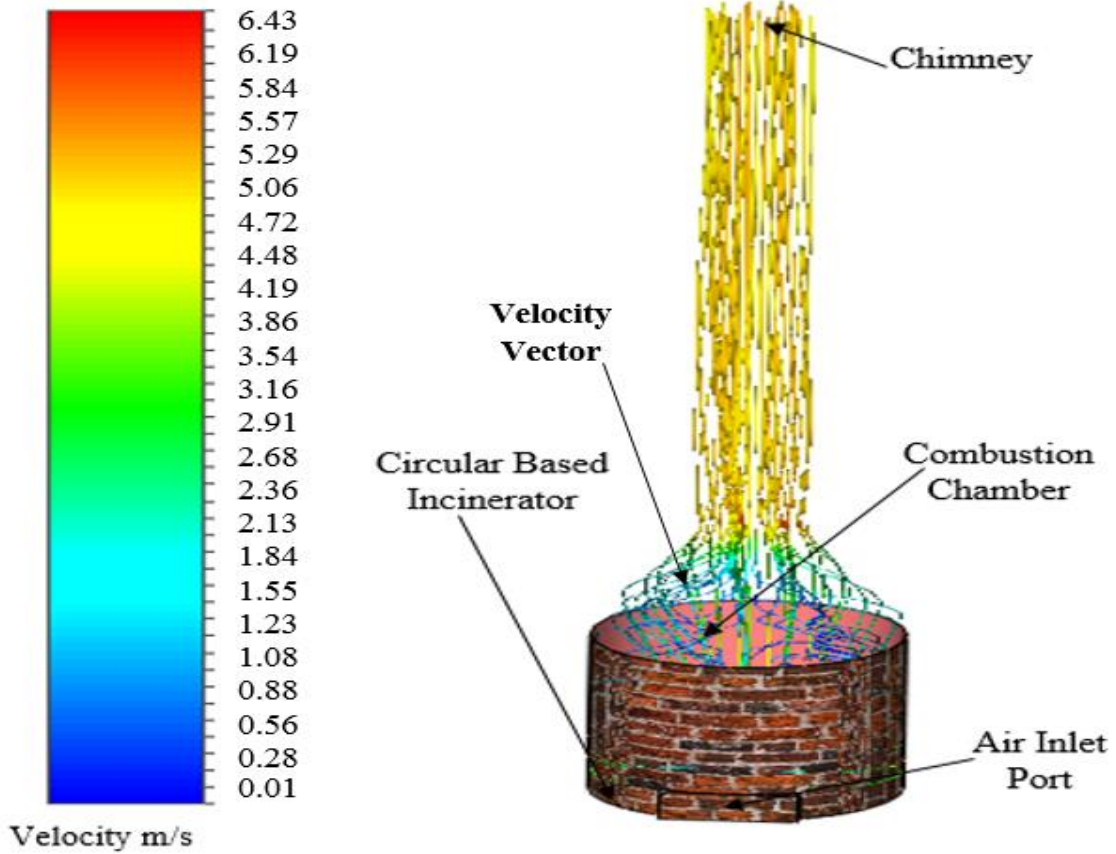

Figure A1.5: Circular based incinerator model Air flow patterns and velocity profiles.

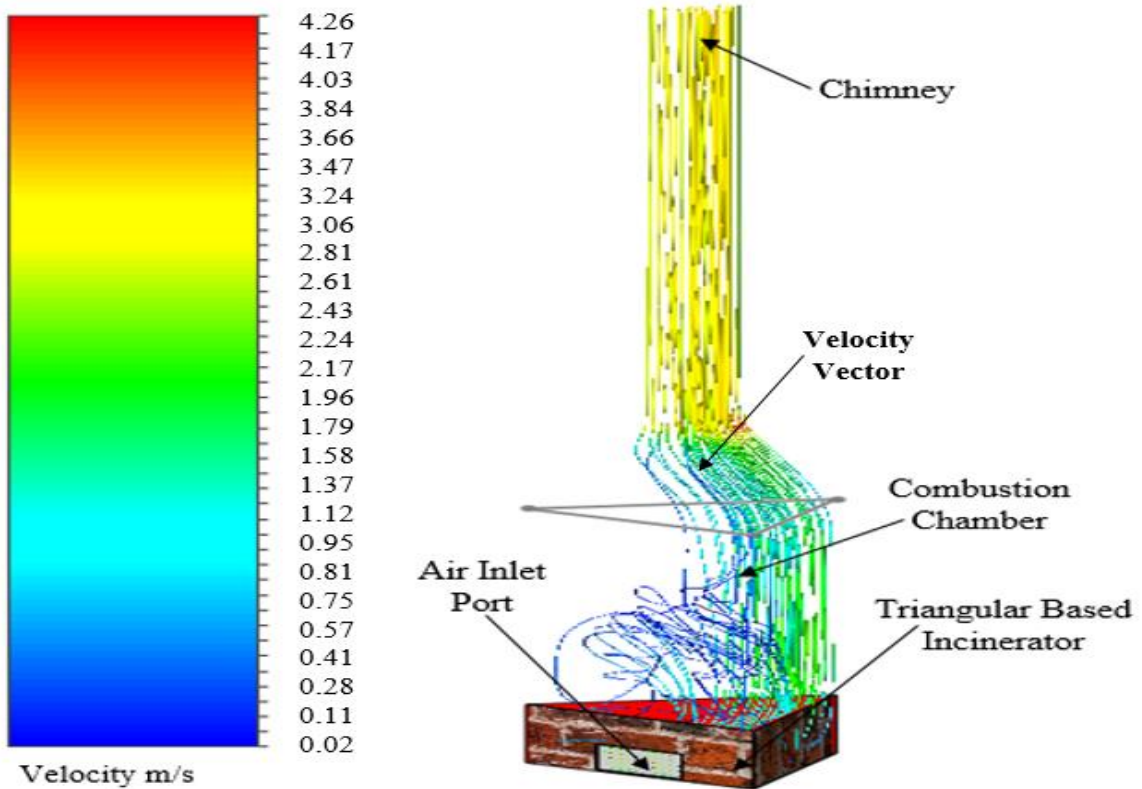

Figure A1.6: Triangular based incinerator model air flow patterns and velocity profiles.

APPENDIX II

Characterization and Incineration Processes Raw Data

Table A2.1: Solid waste characterization of moisture content, volatile matter, ash content, fixed carbon, density and caloric value raw data.

Collection Areas	Moisture content (%)			Volatile Matter (%)			Ash content (%)		
	R1	R2	R3	R1	R2	R3	R1	R2	R3
Njokerio Area	49.87	51.56	52.43	23.75	24.05	23.82	16.19	18.87	18.41
Green Valley Area	37.49	41.51	40.23	36.25	34.98	33.34	14.76	16.63	15.37
Egerton University	27.78	25.52	29.37	46.71	48.16	45.01	11.03	9.14	10.02
Ng'onde	45.67	51.52	44.91	29.72	26.61	26.25	15.45	18.44	15.23

Collection Areas	Fixed Carbon (%)			Density (Kg/m ³)			Heat Energy (MJ/kg)		
	R1	R2	R3	R1	R2	R3	R1	R2	R3
Njokerio Area	6.76	7.58	6.72	324.3	301.9	296.7	5.23	4.61	5.03
Green Valley Area	10.38	9.47	10.19	261.4	245.3	248.6	6.21	7.17	6.04
Egerton University	15.26	15.54	16.46	181.7	186.6	188.1	14.95	16.86	15.79
Ng'onde	10.07	9.75	11.36	279.6	283.8	289.5	12.32	12.15	13.13

Table A2.2: Waste incineration at varying moisture content of 15 and 30 % raw data.

Tim	Moisture Content at 15%									Moisture Content at 30%								
	CO (ppm)			CO ₂ (%)			HC (ppm)			CO (ppm)			CO ₂ (%)			HC (ppm)		
	R1	R2	R3	R1	R2	R3	R1	R2	R3	R1	R2	R3	R1	R2	R3	R1	R2	R3
0	0	0	0	0	0	0	36	34	35	0	0	0	0	0	0	36	34	35
10	1.2	1.3	1.8	1.4	1.4	1.5	428	452	437	1.2	1.3	0.3	1.0	1.2	1.1	650	673	668
20	3.1	3.3	3.7	4.7	4.9	5.1	586	617	596	2.7	3.1	2.3	4.7	5.3	3.9	837	862	839
30	4.8	5.0	4.5	6.4	7.5	8.2	762	788	776	5.9	6.4	5.0	9.1	10.3	8.5	1012	1149	1116
40	5.4	6.3	5.7	9.2	10.2	11.1	947	969	954	11.2	11.9	9.3	12.1	13.1	11.4	1202	1324	1302
50	7.9	8.7	8.4	10.7	11.1	12.3	1183	1203	1192	13.5	14.2	11.7	15.5	17.5	13.8	1384	1427	1406
60	10.4	12.4	11.7	12.2	13.9	14.1	1431	1503	1490	14.3	15.2	10.4	15.1	16.4	14.6	1513	1632	1602
70	9.0	10.1	9.5	10.2	11.6	13.3	1234	1254	1243	11.2	13.1	9.1	13.4	14.4	11.6	1213	1244	1229
80	7.7	8.8	8.0	8.6	9.1	10.3	1041	1102	1068	8.4	9.1	6.8	10.6	11.1	9.1	1032	1134	1121
90	5.6	7.2	6.8	6.1	7.2	8.4	831	921	902	6.4	7.1	5.7	8.1	9.4	8.2	762	851	812
100	4.0	4.6	4.2	3.2	3.3	3.5	545	634	608	4.6	5.0	4.1	6.5	7.4	5.2	677	730	710
110	2.4	3.8	3.3	2.0	2.5	2.9	270	301	282	3.5	4.5	2.8	4.6	5.2	3.3	456	513	509
120	1.4	2.4	2.0	1.3	1.4	1.4	132	139	136	2.6	3.3	1.7	2.8	3.2	1.6	216	238	227
130	1.0	1.5	1.2	0.8	0.8	0.9	92	109	98	1.7	2.1	1.1	1.8	2.1	1.1	125	134	129
140	0.6	0.6	0.2	0.3	0.4	0.5	59	69	63	0.6	0.8	0.6	0.9	1.0	0.9	73	88	81
150	0.1	0.1	0.1	0.2	0.3	0.3	31	37	34	0.3	0.3	0.1	0.4	0.6	0.3	45	51	49

Table A2.3: Waste incineration at varying moisture content of 45 and 60% raw data.

Tim	Moisture Content at 45%									Moisture Content at 60%								
	CO (ppm)			CO ₂ (%)			HC (ppm)			CO (ppm)			CO ₂ (%)			HC (ppm)		
	RI	R2	R3	RI	R2	R3	RI	R2	R3	RI	R2	R3	RI	R2	R3	RI	R2	R3
0	0	0	0	0	0	0	36	32	29	0	0	0	0	0	0	34	36	33
10	2.5	2.3	2.2	3.3	4.3	5.2	574	645	635	3.3	2.7	2.4	5.0	4.2	3.9	313	673	660
20	6.9	7.0	5.9	9.2	10.6	11.9	720	846	826	8.2	7.4	6.9	11.6	9.8	8.2	427	1155	1095
30	11.3	12.6	11.0	12.9	15.2	18.6	921	971	999	15.5	14.8	13.4	19.7	17.3	16.6	850	1404	1205
40	17.4	16.7	15.1	18.4	20.8	26.4	1078	1115	1147	17.8	16.8	15.4	23.9	21.2	19.3	1103	1831	1456
50	19.7	18.9	18.0	25.3	28.8	29.5	1346	1404	1414	21.8	20.2	19.4	26.5	23.9	23.4	1884	2115	2050
60	17.2	16.7	15.2	18.7	20.8	22.7	1735	1810	1821	18.9	17.2	15.3	28.4	24.5	25.8	1795	1956	1815
70	15.4	14.1	13.4	13.6	16.0	16.2	1521	1608	1676	15.9	14.4	13.7	24.1	23.8	22.4	1613	1853	1783
80	13.2	12.6	10.2	9.5	10.6	11.8	1369	1426	1453	12.5	11.5	9.9	21.6	18.4	16.9	1481	1629	1546
90	9.2	8.1	7.2	7.2	8.7	9.5	1174	1219	1367	11.9	10.5	7.5	14.5	12.0	11.7	1146	1314	1256
100	7.2	5.3	4.2	5.1	7.0	7.1	922	1056	1164	8.6	7.9	6.3	10.0	5.9	4.4	1012	1134	986
110	4.0	3.6	3.0	3.3	4.0	5.1	804	835	869	7.8	6.0	5.7	7.2	4.6	3.3	765	976	853
120	3.2	2.8	2.2	2.5	3.3	3.8	565	629	674	5.4	4.6	3.9	5.2	3.3	2.2	522	861	618
130	2.2	1.9	1.4	1.9	2.2	2.8	358	428	456	3.3	2.8	1.7	2.7	1.7	1.4	326	498	423
140	1.0	0.9	0.8	1.0	1.1	1.2	207	291	306	1.6	1.3	0.7	1.5	0.8	0.6	127	266	217
150	0.1	0.5	0.1	0.3	0.1	0.4	120	136	145	0.5	0.3	0.2	0.6	0.3	0.1	47	158	137

Table A2.4: Waste incineration at varying moisture content of 75% raw data.

Time	Moisture Content at 75%								
	CO (ppm)			CO ₂ (%)			HC (ppm)		
	R1	R2	R3	R1	R2	R3	R1	R2	R3
0	0	0	0	0	0	0	36	35	24
10	3.2	3.3	3.7	3.9	3.2	2.8	143	351	266
20	11.6	8.4	9.9	9.5	8.7	7.5	355	884	686
30	14.7	12.4	13.3	16.8	15.2	14.7	834	1825	1331
40	18.6	14.7	16.4	23.4	21.2	18.8	1423	2046	1581
50	23.9	21.8	22.8	27.2	24.7	18.4	2015	2265	2049
60	27.4	24.5	25.8	29.4	26.3	24.3	2256	2517	2349
70	22.1	18.0	18.7	25.7	23.7	21.6	2053	2327	2087
80	17.8	13.6	15.1	20.4	19.4	18.5	1829	2218	1908
90	14.6	11.5	13.0	17.5	16.3	14.4	1614	2071	1887
100	13.0	9.8	10.3	14.4	13.7	11.3	1334	1758	1621
110	10.9	7.4	8.7	11.0	9.3	8.5	916	1363	1171
120	7.8	5.4	6.3	8.2	7.6	6.4	661	1113	839
130	5.7	3.5	4.5	4.6	5.8	4.1	398	789	585
140	2.3	1.3	2.0	2.4	2.6	2.0	276	482	375
150	0.6	0.4	0.5	0.6	0.8	0.6	58	112	97

Table A2. 5: Wastes incineration at varying loading rates of 15 and 30 kg/h raw data.

Tim	Incinerator Loading Rate at 15 kg/h						Incinerator Loading Rate at 30 kg/h										
	CO (ppm)		CO ₂ (%)		HC (ppm)		CO (ppm)		CO ₂ (%)		HC (ppm)						
	R1	R2	R1	R2	R1	R2	R1	R2	R1	R2	R1	R2	R3				
0	0	0	0	0	0	33	35	31	0	0	0	0	35	27	37		
10	0.9	1.0	0.8	0.9	1.4	1.5	217	225	206	1.2	2.0	1.1	1.5	1.8	503	493	517
20	1.8	2.4	1.5	2.6	3.4	3.8	248	266	224	6.4	7.5	5.8	6.2	7.1	625	619	648
30	3.8	4.4	3.6	6.4	7.9	8.7	325	346	319	10.4	11.1	9.6	12.3	13.2	906	892	925
40	6.4	7.4	6.2	9.5	10.3	11.1	341	364	327	12.6	13.2	12.2	16.1	16.9	1022	1014	1042
50	11.4	12.0	10.9	11.1	12.2	13.8	412	435	391	13.9	14.2	13.2	18.3	20.1	1246	1208	1267
60	12.7	13.1	12.1	10.3	10.7	11.8	527	535	514	15.5	16.0	14.8	14.9	15.3	1435	1413	1451
70	11.1	11.5	11.1	9.2	9.7	10.5	413	454	404	13.9	14.4	13.1	13.3	13.8	1026	978	1049
80	8.8	9.2	8.0	6.5	8.3	9.2	338	355	324	11.6	12.6	10.3	11.2	11.8	737	726	758
90	8.0	8.2	6.3	6.3	7.1	8.3	312	342	305	10.4	11.2	9.1	10.3	10.9	626	605	659
100	6.4	7.1	4.8	4.9	5.4	6.6	243	261	234	8.6	9.3	8.3	8.1	9.2	446	431	465
110	4.2	5.2	3.2	3.9	4.3	5.3	208	261	193	5.9	6.2	5.1	7.2	8.2	337	320	352
120	2.2	3.3	1.6	2.1	2.9	3.5	145	261	132	4.5	5.4	4.1	4.4	7.0	246	213	278
130	1.1	2.5	1.1	1.6	1.3	2.3	117	261	109	2.9	3.1	2.3	3.2	5.8	136	127	163
140	0.8	1.3	0.7	0.8	0.9	1.0	87	261	75	1.3	2.0	1.0	1.1	1.8	106	96	112
150	0.4	0.5	0.3	0.3	0.4	0.6	62	261	43	0.5	0.6	0.4	0.6	1.0	72	58	87

Table A2.6: Wastes incineration raw data at varying loading rates of 45 and 60 kg/h.

Time	Incinerator Loading Rate at 45 kg/h									Incinerator Loading Rate at 60 kg/h								
	CO (ppm)			CO ₂ (%)			HC (ppm)			CO (ppm)			CO ₂ (%)			HC (ppm)		
	R1	R2	R3	R1	R2	R3	R1	R2	R3	R1	R2	R3	R1	R2	R3	R1	R2	R3
0	0	0	0	0	0	0	33	27	36	0	0	0	0	0	0	37	35	32
10	1.2	1.5	1.4	1.9	1.8	1.5	757	678	638	1.4	1.4	1.4	1.9	2.1	2.2	722	749	705
20	4.3	4.8	4.6	8.9	8.4	8.0	981	939	917	5.4	5.1	5.1	5.8	7.7	8.3	934	968	913
30	8.3	9.4	9.2	14.9	14.3	14.0	1023	1093	981	10.5	10.2	10.2	10.6	13.8	14.8	1034	1103	1006
40	11.9	12.4	12.1	19.5	19.4	19.0	1268	1213	1183	13.8	13.3	13.3	14.6	17.9	18.7	1408	1511	1357
50	14.9	15.4	15.1	23.8	22.5	22.2	1464	1429	1393	17.9	16.7	16.7	18.6	20.9	21.7	1647	1703	1612
60	20.5	21.6	21.2	25.3	24.5	24.2	1768	1669	1623	24.6	24.1	24.1	25.7	25.0	27.0	1859	1918	1806
70	18.8	19.4	19.1	21.3	20.5	20.3	1534	1496	1478	22.2	21.2	21.2	22.8	23.8	24.7	1667	1686	1631
80	16.1	16.7	16.3	19.1	18.7	18.5	1335	1280	1245	18.4	18.2	18.2	20.1	22.8	23.6	1460	1484	1428
90	14.9	15.4	15.1	16.7	16.3	16.2	1191	1087	3415	17.1	16.1	16.1	17.5	17.9	18.4	1286	1349	1253
100	11.0	11.8	11.2	13.7	13.2	12.8	823	785	732	13.5	13.1	13.1	14.5	15.9	16.5	1126	1172	1113
110	7.5	9.7	8.7	9.2	8.9	8.4	698	656	622	10.0	9.8	9.8	10.3	12.8	13.6	863	975	837
120	5.3	6.5	5.7	6.9	6.3	5.9	522	592	475	6.6	6.2	6.2	7.5	9.3	11.0	764	882	746
130	2.7	3.9	3.4	4.5	4.1	4.0	375	314	298	4.4	3.6	3.6	5.1	7.7	8.5	599	643	522
140	0.9	1.8	1.3	1.8	1.3	1.0	281	235	219	1.6	1.4	1.4	2.1	3.6	4.2	254	288	228
150	0.4	0.7	0.7	0.6	0.5	0.3	132	121	216	0.5	0.4	0.4	0.4	0.5	0.8	125	109	136

Table A2.7: Solid wastes incineration at varying loading rates of 75 kg/h raw data.

Incinerator Loading Rate at 75 kg/h												
Time	CO (ppm)			CO ₂ (%)			HC (ppm)					
	R1	R2	R3	R1	R2	R3	R1	R2	R3	R1	R2	R3
0	0	0	0	0	0	0	38	32	33			
10	2.2	2	2.4	2.6	2.3	2.1	851	907	832			
20	6	5.7	6.4	8.9	8.6	9.2	1022	1071	981			
30	11.1	10.6	11.3	15.3	14.8	15.8	1468	1505	1418			
40	15.6	15.2	15.9	19.1	18.8	19.4	1697	1710	1627			
50	18.7	18.4	19.3	22.6	22.2	23.2	1815	1929	1791			
60	26.1	25.3	26.9	27.9	26.7	27.9	2046	2116	2014			
70	23.5	22.2	23.8	25.2	24.7	25.6	1784	1905	1734			
80	21.5	20.4	21.7	22.2	21.7	22.6	1625	1662	1573			
90	18.5	18.2	18.8	20.3	19.9	20.8	1336	1374	1312			
100	15.2	14.7	15.9	17.3	16.8	17.8	1110	1135	1081			
110	11.2	10.5	11.5	14.7	14.1	15.1	1009	1027	995			
120	11	10.4	10.7	11.7	11.2	12.5	825	906	792			
130	6.4	5	6.7	9.5	8.7	8.2	406	485	387			
140	2.7	1.8	3	5.4	4.3	5.8	285	302	241			
150	0.7	0.5	0.6	1.4	1.1	1.1	146	152	118			

Table A2.8: Waste incineration at varying operating temperatures of 180 and 360°C.

Tim	Operating Temperature Level 180°C						Operating Temperature Level 360°C											
	CO (ppm)		CO ₂ (%)		HC (ppm)		CO (ppm)		CO ₂ (%)		HC (ppm)							
	R1	R2	R3	R1	R2	R3	R1	R2	R3	R1	R2	R3						
0	0	0	0	0	0	0	35	34	32	0	0	0	0	0	0	33	31	36
10	2.7	2.4	2.2	2.5	2.3	2.1	762	733	705	2.9	5.1	3.9	2.7	2.3	1.9	684	606	593
20	9.9	9.2	8.5	9.4	8.9	7.9	1103	1089	1133	9.9	10.6	10.5	9.7	9.3	9.1	1104	1098	1003
30	14.1	13.3	12.9	14.4	14.1	13.9	1464	1353	1206	16.7	18.7	16.1	18.7	17.7	16.9	1529	1412	1375
40	18.3	18.1	17.4	20.4	19.6	19.2	1731	1663	1597	23.2	24.3	22.4	22.2	21.9	20.9	1607	1523	1571
50	24.2	23.2	22.9	24.2	23.6	22.6	2278	1981	2037	24.9	26.3	23.6	26.3	25.6	24.9	1911	1836	1897
60	26.8	25.8	25.3	27.9	26.7	26.0	2369	2284	2215	22.2	24.4	22.1	25.8	24.7	23.8	1974	1905	1915
70	24.7	24.3	23.9	26.6	25.8	24.1	2096	1896	1761	15.4	16.1	15.2	20.7	19.8	18.9	1814	1702	1624
80	22.5	22.2	22.1	25.9	24.4	22.8	1986	1760	1698	12.9	13.8	11.4	18.6	17.8	16.8	1639	1602	1545
90	22.0	21.2	20.7	23.6	22.6	21.2	1726	1627	1593	11.3	12.1	10.6	15.4	14.9	13.6	1535	1443	1372
100	18.8	18.2	17.9	21.9	21.3	20.5	1683	1585	1473	8.2	9.4	8.9	14.1	11.9	10.7	1224	1168	1131
110	16.8	16.4	16.1	19.4	18.8	17.3	1532	1466	1267	6.3	7.2	7.3	10.7	9.4	8.8	963	907	814
120	14.9	14.3	13.4	15.2	14.9	14.1	1235	1192	846	4.7	5.2	4.2	8.7	7.8	6.8	662	596	543
130	8.5	7.7	6.6	11.1	10.1	9.3	844	728	622	2.9	3.7	2.6	6.7	5.7	4.9	469	387	332
140	3.6	3.1	2.9	6.4	5.9	5.2	485	386	375	1.2	1.5	1.4	2.4	2.1	1.9	295	286	244
150	0.5	0.4	0.4	0.8	0.6	0.5	138	216	138	0.6	0.6	0.6	0.7	0.6	0.5	133	139	132

Table A2.9: Waste incineration at varying operating temperatures of 540 and 720°C.

Tim	Operating Temperature Level 540°C						Operating Temperature Level 720°C									
	CO (ppm)		CO ₂ (%)		HC (ppm)		CO (ppm)		CO ₂ (%)		HC (ppm)					
	R1	R2	R3	R1	R2	R3	R1	R2	R3	R1	R2	R3				
0	0	0	0	0	0	0	35	33	32	0	0	0	0	35	37	33
10	3.4	3.2	3.2	2.2	3.9	3.2	655	634	545	0.8	1.0	1.2	2.8	1.7	1.8	324
20	9.9	8.8	10.4	8.7	8.1	8.3	856	787	746	3.6	4.8	4.4	7.5	7.3	6.7	414
30	15.6	14.9	16.8	15.1	15.2	14.8	926	865	833	8.3	8.8	9.8	12.1	11.4	10.4	569
40	22.7	20.5	19.2	19.7	20.2	19.4	1184	1089	1055	13.2	13.4	13.9	14.3	13.3	12.4	787
50	25.0	23.2	22.7	23.3	25.3	24.8	1535	1526	1482	13.7	13.9	14.7	19.9	17.6	16.5	1051
60	17.7	16.5	15.2	18.9	20.3	19.4	1474	1384	1343	12.3	12.7	13.1	16.2	15.7	14.9	1244
70	9.7	11.3	12.4	15.1	15.7	15.4	1318	1262	1235	9.1	9.9	10.1	13.6	12.8	11.1	1084
80	6.8	7.5	9.5	12.1	12.9	12.3	1233	1127	1074	8.4	8.6	9.5	11.9	9.4	9.3	829
90	5.4	5.5	7.6	10.2	11.3	10.3	1115	1025	918	7.4	7.2	8.5	9.8	8.6	7.1	585
100	4.4	4.6	6.5	8.2	8.7	7.9	983	921	878	5.2	5.5	6.5	8.6	7.3	6.8	494
110	3.7	3.9	5.1	6.7	7.3	5.7	914	888	738	4.8	5.6	6.0	6.6	5.8	4.3	363
120	2.4	2.8	3.8	4.5	5.6	4.8	686	663	589	3.9	4.3	4.6	4.7	4.5	3.8	282
130	2.0	2.2	2.4	2.8	3.8	2.6	583	537	424	1.9	2.5	2.8	2.9	2.7	2.5	189
140	0.8	0.9	1.1	1.5	1.4	1.8	289	236	228	0.8	0.9	1.0	1.1	0.9	0.8	95
150	0.4	0.4	0.5	0.6	0.8	0.8	128	112	106	0.3	0.4	0.4	0.5	0.5	0.4	35

Table A2.10: Waste incineration at varying operating temperatures of 900°C.

Operating Temperature Level 900°C												
Tim	CO (ppm)			CO ₂ (%)			HC (ppm)					
	R1	R2	R3	R1	R2	R3	R1	R2	R3	R1	R2	R3
0	0	0	0	0	0	0	0	0	0	27	28	26
10	1	1.2	0.8	2	1.8	1.2	183	191	172			
20	2.3	3.1	2.5	6.2	5	4.2	312	323	302			
30	6.3	6.7	6.1	9.8	8.9	5.5	412	431	385			
40	10.0	10.6	10.0	12.5	11.3	7.3	524	542	515			
50	12.3	12.7	12.1	13.8	12.2	11.8	830	843	822			
60	12.7	13.1	12.6	14.5	13.4	12.4	905	924	893			
70	9.1	9.4	7.8	11.0	10.6	10.4	711	723	684			
80	8.1	8.6	6.6	9.6	9.3	8.5	503	522	486			
90	6.1	6.3	5.5	8.6	8.3	7.9	313	321	302			
100	5.0	5.2	4.3	6.9	6.4	6.3	210	223	206			
110	3.2	3.5	2.7	5.8	4.8	4.8	131	143	122			
120	2.1	2.4	1.7	3.7	3.4	3.4	82	94	77			
130	1.3	1.6	1.2	2.5	2.1	2.3	57	61	52			
140	0.9	1	0.8	1	1	0.9	42	50	41			
150	0.4	0.4	0.3	0.5	0.4	0.4	33	34	31			

APPENDIX III

ANOVA Results and Critical F-Values

Table A3.1: Mean and standard deviation results from solid waste incineration.

Solid Waste Incineration	No. Rep	Carbon Monoxide (ppm)		Carbon Dioxide (%)		Hydrocarbon (ppm)	
		Mean	Std Dev	Mean	Std Dev	Mean	Std Dev
MC of 15%	3	4.6193	0.1473	5.3414	0.1497	507.923	42.434
MC of 30%	3	5.7446	0.3678	7.1493	0.2715	688.128	59.356
MC of 45%	3	7.5394	0.4351	9.7431	0.5324	856.816	76.173
MC of 60%	3	8.8732	0.5463	11.4224	0.8506	1024.734	92.856
MC of 75%	3	10.9451	0.7347	13.8343	1.2673	1168.336	112.334
LR of 15 kg/h	3	5.0224	0.2132	5.4281	0.2485	252.426	17.286
LR of 30 kg/h	3	7.4743	0.4598	8.5832	0.5277	594.348	48.672
LR of 45 kg/h	3	9.0531	0.6886	11.3524	0.9875	837.119	72.245
LR of 60 kg/h	3	10.5345	0.7743	12.9631	1.1372	993.235	94.863
LR of 75 kg/h	3	11.7842	0.9157	13.8892	1.2313	1096.128	102.128
OTL of 180°C	3	13.7434	1.2136	14.9112	1.2847	1253.343	118.236
OTL of 360°C	3	10.4563	0.8532	11.9734	0.9323	1049.351	94.723
OTL of 540°C	3	8.1571	0.7213	9.6132	0.5217	817.447	79.547
OTL of 720°C	3	6.2392	0.4502	7.4951	0.3602	566.025	46.362
OTL of 900°C	3	5.0334	0.2236	6.1334	0.2351	316.043	22.756

Where: MC-Moisture Content; LR-loading Rate; OTL-Operating Temperature Levels

Table A3.2: Critical Values of F-Distribution at 5 percent

v_1/v_2	1	2	3	4	5	6	7	8	12	24	∞
1	161.4	199.5	215.7	224.6	230.2	234.0	237	238.9	243.9	249.1	243.3
2	18.51	19.00	19.16	19.25	19.30	19.33	19.4	19.37	19.41	19.45	19.50
3	10.13	9.55	9.28	9.12	9.01	8.94	8.89	8.85	8.74	8.64	8.53
4	7.71	6.94	6.59	6.39	6.26	6.16	6.09	6.04	5.91	5.77	5.63
5	6.61	5.79	5.41	5.19	5.05	4.95	4.88	4.82	4.68	4.53	4.36
6	5.99	5.14	4.76	4.53	4.39	4.28	4.21	4.15	4.00	3.84	3.67
7	5.59	4.74	4.35	4.12	3.97	3.87	3.79	3.73	3.57	3.41	3.23
8	5.32	4.46	4.07	3.84	3.69	3.58	3.50	3.44	3.28	3.12	2.93
9	5.12	4.26	3.86	3.63	3.48	3.37	3.29	3.23	3.07	2.90	2.71
10	4.96	4.10	3.71	3.48	3.33	3.22	3.14	3.07	2.91	2.74	2.54
11	4.84	3.98	3.59	3.36	3.20	3.09	3.01	2.95	2.79	2.61	2.40
12	4.75	3.88	3.49	3.26	3.11	3.00	2.91	2.85	2.69	2.51	2.30
13	4.67	3.80	3.41	3.18	3.02	2.92	2.83	2.77	2.60	2.42	2.21
14	4.60	3.74	3.34	3.11	2.96	2.85	2.76	2.70	2.53	2.35	2.13
15	4.54	3.68	3.29	3.06	2.90	2.79	2.66	2.64	2.48	2.29	2.07
16	4.49	3.63	3.24	3.01	2.85	2.74	2.61	2.59	2.42	2.24	2.01
17	4.45	3.59	3.20	2.96	2.81	2.70	2.58	2.55	2.38	2.19	1.96
18	4.41	3.55	3.16	2.93	2.77	2.66	2.54	2.51	2.34	2.15	1.92
19	4.38	3.52	3.13	2.90	2.74	2.63	2.52	2.48	2.31	2.11	1.88
20	4.35	3.49	3.10	2.87	2.71	2.60	2.51	2.45	2.28	2.08	1.84
21	4.32	3.47	3.07	2.84	2.68	2.57	2.49	2.42	2.25	2.05	1.81
22	4.30	3.44	3.05	2.82	2.66	2.55	2.46	2.40	2.23	2.03	1.78
23	4.28	3.42	3.03	2.80	2.64	2.53	2.44	2.38	2.20	2.01	1.76
24	4.26	3.40	3.01	2.78	2.62	2.51	2.42	2.36	2.18	1.98	1.73
25	4.24	3.38	2.99	2.76	2.60	2.49	2.40	2.34	2.16	1.96	1.71
26	4.22	3.37	2.98	2.74	2.59	2.47	2.39	2.32	2.15	1.95	1.69
27	4.21	3.35	2.96	2.73	2.57	2.46	2.37	2.31	2.13	1.93	1.67
28	4.20	3.34	2.95	2.71	2.56	2.45	2.35	2.29	2.12	1.91	1.65
29	4.18	3.33	2.93	2.70	2.54	2.43	2.34	2.28	2.10	1.90	1.64
30	4.17	3.32	2.92	2.69	2.53	2.42	2.33	2.27	2.09	1.89	1.62
40	4.08	3.23	2.84	2.61	2.45	2.34	2.25	2.18	2.00	1.79	1.51
50	4.03	3.18	2.79	2.56	2.40	2.29	2.20	2.13	1.19	1.74	1.43
60	4.00	3.15	2.76	2.52	2.37	2.25	2.18	2.10	1.92	1.70	1.39
120	3.92	3.07	2.68	2.45	2.29	2.17	2.11	2.02	1.83	1.61	1.25
∞	3.84	2.99	2.60	2.37	2.21	2.10	2.01	1.94	1.75	1.52	1.00

Table A3.3: ANOVA results of solid waste characterization from different areas

(i) Dependent Variable: Moisture content

Source	<i>DF</i>	Sum of Squares	Mean Square	<i>F-Value</i>	<i>Pr > F</i>
Model	3	983.097123	327.699135	57.630591	0.0001156032
Error	8	45.4896235	5.68621274		
Corrected Total	11	1028.57216			

(ii) Dependent Variable: volatile matters

Source	<i>DF</i>	Sum of Squares	Mean Square	<i>F-Value</i>	<i>Pr > F</i>
Model	3	906.574823115	302.19161	145.957812	0.00191121
Error	8	16.5632344324	2.0704043		
Corrected Total	11	1250.16411232			

(iii) Dependent Variable: Ash Content

Source	<i>DF</i>	Sum of Squares	Mean Square	<i>F-Value</i>	<i>Pr > F</i>
Model	3	103.6987013	34.5662338	19.5481335	0.000165854
Error	8	14.1461010	1.7682626		
Corrected Total	11	117.8448000			

(iv) Dependent Variable: Fixed carbon

Source	<i>DF</i>	Sum of Squares	Mean Square	<i>F-Value</i>	<i>Pr > F</i>
Model	3	118.8241337	39.60803	99.85323323	0.000179143
Error	8	3.173311233	0.396663		
Corrected Total	11	126.1715112			

(v) Dependent Variable: Density

Source	<i>DF</i>	Sum of Squares	Mean Square	<i>F-Value</i>	<i>Pr > F</i>
Model	3	25358.15312	8452.7181133	104.51961	0.0001140192
Error	8	646.9769113	80.872111233		
Corrected Total	11	26005.13115			

(vi) Dependent Variable: Colorific value

Source	<i>DF</i>	Sum of Squares	Mean Square	<i>F-Value</i>	<i>Pr > F</i>
Model	3	236.1027583	78.7009194	189.408764	0.0001179109
Error	8	3.324066667	0.41550833		
Corrected Total	11	239.426825			

Table A3.4: ANOVA results for solid waste incineration processes**a) Moisture Content at 15, 30, 45, 60 and 75%**

i. Dependent Variable: CO

Source	<i>DF</i>	Sum of Squares	Mean Square	<i>F-Value</i>	<i>Pr > F</i>
Model	4	157.011977	39.252994	1.07971169	0.0001013426
Error	75	2726.63034	36.355071		
Corrected Total	79	3151.11871			

ii. Dependent Variable: CO₂

Source	<i>DF</i>	Sum of Squares	Mean Square	<i>F-Value</i>	<i>Pr > F</i>
Model	4	546.506011	136.626523	2.319463	0.000101467
Error	75	4417.82692	58.9043616		
Corrected Total	79	4964.33291			

iii. Dependent Variable: HC

Source	<i>DF</i>	Sum of Squares	Mean Square	<i>F-Value</i>	<i>Pr > F</i>
Model	4	3196667.68	799166.7	2.1529917	0.00011709
Error	75	27839169.37	371188.9		
Corrected Total	79	303711294.23			

b) Incinerator loading rate of 15, 30, 45, 60 and 75 kg/hr

i. Dependent Variable: CO

Source	<i>DF</i>	Sum of Squares	Mean Square	<i>F-Value</i>	<i>Pr > F</i>
Model	4	448.207123	112.0518123	2.4478353	0.0001015442
Error	75	3433.19224	45.77589112		
Corrected Total	79	4502.86612			

ii. Dependent Variable: CO₂

Source	<i>DF</i>	Sum of Squares	Mean Square	<i>F-Value</i>	<i>Pr > F</i>
Model	4	762.6932243	190.67331147	3.45413923	0.000101705
Error	75	4140.103231	55.201381234		
Corrected Total	79	4902.796132			

iii. Dependent Variable: HC

Source	<i>DF</i>	Sum of Squares	Mean Square	<i>F-Value</i>	<i>Pr > F</i>
Model	4	7513005.73265	1878251.113	7.43492516	0.000118099
Error	75	18946910.3327	252625.5231		
Corrected Total	79	26459916.2314			

c) Operating Temperature Levels of 180, 360, 540, 720 and 900°C

(i) Dependent Variable: CO

Source	<i>DF</i>	Sum of Squares	Mean Square	<i>F-Value</i>	<i>Pr > F</i>
Model	4	819.2214162	204.8054023	4.46598623	0.00010118
Error	75	3210.126123	45.85894112		
Corrected Total	79	4029.347115			

(ii) Dependent Variable: CO₂

Source	<i>DF</i>	Sum of Squares	Mean Square	<i>F-Value</i>	<i>Pr > F</i>
Model	4	945.4569123	236.36421342	5.2190961	0.000102681
Error	75	3170.184122	45.288350433		
Corrected Total	79	4115.641124			

(iii) Dependent Variable: HC

Source	<i>DF</i>	Sum of Squares	Mean Square	<i>F-Value</i>	<i>Pr > F</i>
Model	4	8770486.112	2192621.428	8.44509613	0.0001029902
Error	75	19472438.117	259632.5126		
Corrected Total	79	28242921.107			

The Research License



NATIONAL COMMISSION FOR SCIENCE, TECHNOLOGY & INNOVATION

Date of Issue: 13/April/2021

RESEARCH LICENSE



This is to Certify that Mr., Stephen Mugo Nyoti of Egerton University, has been licensed to conduct research in Nakuru on the topic: PERFORMANCE OF SMALL-SCALE SOLID WASTE INCINERATORS AT NJOKERIO AND NG'ONDU IN NJORO, KENYA for the period ending - 13/April/2022.

License No: NACOSTIP/21/9986

Applicant Identification Number: 833462

Director General
NATIONAL COMMISSION FOR SCIENCE, TECHNOLOGY & INNOVATION

Verification QR Code



NOTE: This is a computer generated License. To verify the authenticity of this document, Scan the QR Code using QR scanner application.

The Journal Publication Abstract

Solid waste management is challenging and incineration technique is more preferred to other methods in reduction of mass and volume, removal of odour and energy recovery in both industrial and residential environments. The challenges facing residents at Njokerio, Ng'onde and Green Valley estates in Njoro, Kenya included poorly designed open-wastes collection systems, exceeding incinerator loading rates and inappropriate operating temperatures. It also include inadequate design specifications, poorly mixed solid wastes with high moisture contents resulting to high emissions of noxious heavy dense smoke. The aim of this study was to evaluate factors influencing flue gas emissions and performance of small-scale incinerators. Data collected were statistically analysed to determine trends, means, F-values and Least Significant Different (LSD) at $\alpha = 0.05$. Wastes incineration at varying moisture contents (MC) from 15 to 75% produced mean emission values for carbon monoxide (CO), carbon dioxide (CO₂), and hydrocarbon (HC) ranging between 5 and 11 ppm, 5 and 14%, and from 508 to 1168 ppm, respectively. Varying the incinerator loading rates from 15 to 75 kg/h yielded means CO ranging between 5 and 12 ppm, CO₂ from 5 to 14%, and HC between 252 and 1096 ppm. Waste incineration at varying operating temperature levels from 180 to 900°C contributed to mean emissions for CO, CO₂ and HC ranging from 14 to 5 ppm, 15 to 6% and 1253 to 316 ppm, respectively. The Egerton University dispensary incinerator had the best incineration performance compared to the rest. High moisture contents, overloaded incinerators and low operating temperature levels contributed to high emission levels of flue gases leading to dark and dense smoke which resulted into incomplete wastes combustion indicating poor incineration performance. Wastes incineration at low loading rates, low moisture contents and high operating temperatures produced white and fine bottom ash, low levels of carbon, implying complete wastes combustion.

How to reference

Nyoti S., Nyaanga D., Owido S., & Owino G. (2020). Flue gas emissions and performance evaluation of small-scale solid waste incinerators at Njokerio and Ng'onde in Njoro, Kenya. *Journal of Engineering Research and Reports (JERR)*, 18(2): 50-66.